



Vehicle History Report™

2007 MERCEDES-BENZ GL-CLASS GL 450

VIN: 4JGBF71EX7A217520
4 DOOR WAGON/SPORT
UTILITY
4.7L V8 F SOHC 32V
GASOLINE
ALL WHEEL DRIVE

Damage reported: minor damage

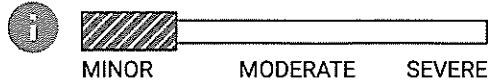

29 Service history records

At least 1 open recall

3 Previous owners

158,900 Last reported odometer reading

This CARFAX Vehicle History Report is based only on information supplied to CARFAX and available as of 7/10/24 at 1:37:02 PM (CDT). Other information about this vehicle, including problems, may not have been reported to CARFAX. Use this report as one important tool, along with a vehicle inspection and test drive, to make a better decision about your next used car.



Accident / Damage History

Not all accidents / issues are reported to CARFAX

Event 1

10/25/2017

Damage reported: minor damage

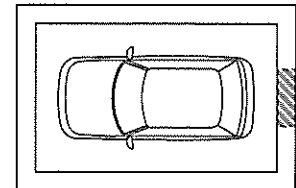
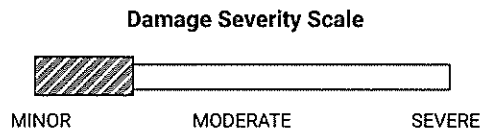

Additional History

Not all accidents / issues are reported to CARFAX

Total Loss

No total loss reported to CARFAX.

Owner 1

No Issues Reported

Owner 2

No Issues Reported

Owner 3

No Issues Reported

Structural Damage

CARFAX recommends that you have this vehicle inspected by a collision repair specialist.

No Issues Reported

No Issues Reported

No Issues Reported

[^ Back To Top](#)

Airbag Deployment No airbag deployment reported to CARFAX.	<input checked="" type="checkbox"/> No Issues Reported	<input checked="" type="checkbox"/> No Issues Reported	<input checked="" type="checkbox"/> No Issues Reported
Odometer Check No indication of an odometer rollback.	<input checked="" type="checkbox"/> No Issues Indicated	<input checked="" type="checkbox"/> No Issues Indicated	<input checked="" type="checkbox"/> No Issues Indicated
Accident / Damage Damage reported: 10/25/2017.	<input checked="" type="checkbox"/> No Issues Reported	Minor Damage	No New Issues Reported
Manufacturer Recall At least 1 manufacturer recall requires repair. Most recalls can be repaired free of charge.	<input checked="" type="checkbox"/> No Recalls Reported	<input checked="" type="checkbox"/> No Recalls Reported	Recall Reported
Basic Warranty Original warranty estimated to have expired.	Warranty Expired	Warranty Expired	Warranty Expired

 Title History CARFAX guarantees the information in this section	Owner 1	Owner 2	Owner 3
Damage Brands Salvage Junk Rebuilt Fire Flood Hail Lemon	<input checked="" type="checkbox"/> Guaranteed No Problem	<input checked="" type="checkbox"/> Guaranteed No Problem	<input checked="" type="checkbox"/> Guaranteed No Problem
Odometer Brands Not Actual Mileage Exceeds Mechanical Limits	<input checked="" type="checkbox"/> Guaranteed No Problem	<input checked="" type="checkbox"/> Guaranteed No Problem	<input checked="" type="checkbox"/> Guaranteed No Problem

GUARANTEED - None of these title problems were reported by a U.S. state Department of Motor Vehicles (DMV). If you find that any of these title problems were reported by a DMV and not included in this report, you may qualify.
[View Terms](#) | [View Certificate](#)

 Ownership History The number of owners is estimated	Owner 1	Owner 2	Owner 3
Year purchased	2006	2009	2019
Type of owner	Personal lease	Personal	Personal
Estimated length of ownership	1 yr. 11 mo.	10 yrs. 9 mo.	4 yrs. 8 mo.
Owned in the following states/provinces	Texas	Texas, Pennsylvania	Pennsylvania
Estimated miles driven per year	18,543/yr	10,718/yr	60/yr
Last reported odometer reading	37,506	151,852	158,900

 **Detailed History**

[^ Back To Top](#)

**Owner 1**

Purchased: 2006

Personal Lease

Vehicle

18,543 mi/yr

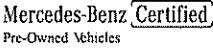
Date	Mileage	Source	Comments
12/29/2006	9	Texas Inspection Station Dallas, TX	Emissions inspection performed - Passed safety inspection
12/30/2006		Texas Motor Vehicle Dept. Roanoke, TX	Titled or registered as personal lease vehicle
01/24/2007	89	Texas Motor Vehicle Dept. College Station, TX	Title issued or updated - First owner reported - Loan or lien reported
12/01/2007		Texas Motor Vehicle Dept. College Station, TX	Registration issued or renewed - Loan or lien reported - Passed safety inspection
09/26/2008	33,862	Mercedes-Benz of Houston - North Houston, TX 281-305-8970 ★ 4.4 / 5.0 199 Verified Reviews ♥ 309 Customer Favorites	 Vehicle serviced - Maintenance inspection completed - Recommended maintenance performed - Vehicle washed/detailed - Air suspension compressor replaced/repaired
12/01/2008		Texas Motor Vehicle Dept. College Station, TX	Registration issued or renewed - Loan or lien reported - Passed safety inspection - Owner purchased from leasing company
12/19/2008	36,579	Mercedes-Benz Certified Pre-Owned Dealer 	Offered for sale as a Mercedes-Benz Certified Pre-Owned Vehicle - Black Exterior - Java Leather Interior
12/19/2008		Mercedes-Benz of Houston - North Houston, TX 281-305-8970 ★ 4.4 / 5.0 199 Verified Reviews ♥ 309 Customer Favorites	Vehicle offered for sale

[^ Back To Top](#)

12/29/2008 36,580 Mercedes-Benz of Houston - North Houston, TX 281-305-8970
 ☆ 4.4 / 5.0
 199 Verified Reviews
 ♥ 309 Customer Favorites

 **Vehicle serviced**
 - Pre-delivery inspection completed
 - Brakes checked
 - Oil and filter changed
 - Vehicle washed/detailed
 - Emissions inspection performed
 - Emissions or safety inspection performed



Looks like this dealer serviced the car in order to prepare it for sale. That's a good thing!

12/31/2008 36,602 Mercedes-Benz of Houston - North Houston, TX 281-305-8970
 ☆ 4.4 / 5.0
 199 Verified Reviews
 ♥ 309 Customer Favorites

Vehicle sold

01/07/2009 36,603 Mercedes-Benz of Houston - North Houston, TX 281-305-8970
 ☆ 4.4 / 5.0
 199 Verified Reviews
 ♥ 309 Customer Favorites

 **Vehicle serviced**

01/26/2009 37,506 Mercedes-Benz of Houston - North Houston, TX 281-305-8970
 ☆ 4.4 / 5.0
 199 Verified Reviews
 ♥ 309 Customer Favorites

 **Vehicle serviced**
 - Maintenance inspection completed
 - Vehicle washed/detailed

 **Owner 2**
 Purchased: 2009



Low mileage! This owner drove less than the industry average of 15,000 miles per year.

Personal Vehicle
10,718 mi/yr

Date	Mileage	Source	Comments
01/29/2009		Texas Motor Vehicle Dept. Spring, TX	Title issued or updated - New owner reported
01/30/2009	37,769	Mercedes-Benz of Houston - North Houston, TX	 Vehicle serviced - Maintenance inspection - Key(s) (re) programmed





[^ Back To Top](#)

281-305-8970

★ 4.4 / 5.0

199 Verified Reviews

♥ 309 Customer Favorites

06/01/2009	43,954	Mercedes-Benz of Houston - North Houston, TX 281-305-8970 ★ 4.4 / 5.0 199 Verified Reviews ♥ 309 Customer Favorites		Vehicle serviced - Maintenance inspection completed - Recommended maintenance performed - Vehicle washed/detailed
09/09/2009	51,370	Mercedes-Benz of Houston - North Houston, TX 281-305-8970 ★ 4.4 / 5.0 199 Verified Reviews ♥ 309 Customer Favorites		Vehicle serviced - Maintenance inspection completed - Blower motor replaced/repaired - Vehicle washed/detailed
11/30/2009	57,227	Mercedes-Benz of Houston - North Houston, TX 281-305-8970 ★ 4.4 / 5.0 199 Verified Reviews ♥ 309 Customer Favorites		Vehicle serviced - Recommended maintenance performed - Maintenance inspection completed - Outside door handle replaced - Electrical system checked - Vehicle washed/detailed - Four wheel alignment performed - Four tires balanced - Four tires mounted
12/10/2009		Texas Motor Vehicle Dept. Spring, TX		Registration issued or renewed - Passed safety inspection
02/08/2010	60,910	Mercedes-Benz of Houston - North Houston, TX 281-305-8970 ★ 4.4 / 5.0 199 Verified Reviews ♥ 309 Customer Favorites		Vehicle serviced - Electrical system checked - Emissions inspection performed - Emissions or safety inspection performed
02/08/2010		Texas Inspection Station Spring, TX		Passed emissions inspection
04/01/2010	63,532	Mercedes-Benz of Houston - North Houston, TX 281-305-8970		Vehicle serviced - Maintenance inspection completed - Vehicle washed/detailed

[^ Back To Top](#)

★ 4.4 / 5.0

199 Verified Reviews

♥ 309 Customer Favorites

10/05/2010 70,776

Mercedes-Benz of
Houston - North
Houston, TX
281-305-8970**Vehicle serviced**

- Maintenance inspection completed
- Exterior lights checked
- Vehicle washed/detailed

★ 4.4 / 5.0

199 Verified Reviews

♥ 309 Customer Favorites

12/01/2010 74,307

Mercedes-Benz of
Houston - North
Houston, TX
281-305-8970**Vehicle serviced**

- Recommended maintenance performed
- Maintenance inspection completed
- Vehicle washed/detailed
- Brakes checked
- Differential fluid flushed/changed
- Differential serviced
- Tire condition and pressure checked
- Battery/charging system checked
- Power steering checked

★ 4.4 / 5.0

199 Verified Reviews

♥ 309 Customer Favorites

03/15/2011 78,048

Mercedes-Benz of
Houston - North
Houston, TX
281-305-8970**Vehicle serviced**

- Maintenance inspection completed
- Power steering checked
- Camshaft seal(s) replaced
- Air filter replaced
- Vehicle washed/detailed
- Transmission serviced
- Brakes checked
- Battery/charging system checked
- Tire condition and pressure checked
- Emissions inspection performed
- Emissions or safety inspection performed

★ 4.4 / 5.0

199 Verified Reviews

♥ 309 Customer Favorites

03/15/2011 78,053

Texas
Inspection Station
Spring, TX**Passed emissions inspection**

03/25/2011

Texas
Motor Vehicle Dept.
Spring, TX**Title issued or updated**

- Registration issued or renewed
- Passed safety inspection
- Registration updated when owner moved the vehicle to a new location





03/23/2012 93,640

Pennsylvania
Motor Vehicle Dept.
Bryn Mawr, PA**Title issued or updated**

06/12/2012 94,888

Inspection Station

Passed emissions inspe [^ Back To Top](#)

08/09/2012		Pennsylvania Motor Vehicle Dept. Bryn Mawr, PA		Registration issued or renewed
03/20/2013		Pennsylvania Motor Vehicle Dept. Bryn Mawr, PA		Registration issued or renewed
01/14/2014	110,050	Inspection Station		Exempt from emissions inspection
01/28/2014		Pennsylvania Motor Vehicle Dept. Bryn Mawr, PA		Registration issued or renewed
11/25/2014	118,890	Inspection Station		Passed emissions inspection
04/07/2015	123,519	Suburban Collection ★ 4.7 / 5.0 235 Verified Reviews		Vehicle serviced - Alignment performed - Tire(s) replaced - Electrical system checked - Four wheel alignment performed - Tire(s) balanced - Tire(s) mounted
05/02/2015		Pennsylvania Motor Vehicle Dept. Bryn Mawr, PA		Registration issued or renewed
05/23/2015	126,043	Suburban Collection ★ 4.7 / 5.0 235 Verified Reviews		Vehicle serviced - Maintenance inspection completed - Oil and filter changed
01/28/2016	135,610	C S Cantlin Automotive Conshohocken, PA 610-834-1300 ★ 4.7 / 5.0 14 Verified Reviews ♥ 3 Customer Favorites		Vehicle serviced - Thermostat replaced - Emissions inspection performed - Emissions or safety inspection performed
02/17/2016		Inspection Station		Failed emissions inspection
03/22/2016	137,439	C S Cantlin Automotive Conshohocken, PA 610-834-1300 ★ 4.7 / 5.0 14 Verified Reviews ♥ 3 Customer Favorites		Vehicle serviced - Catalytic converter replaced
06/01/2016	140,067	C S Cantlin Automotive Conshohocken, PA 610-834-1300 ★ 4.7 / 5.0 14 Verified Reviews		Vehicle serviced - Headlight bulb(s) replaced

[^ Back To Top](#)

♥ 3 Customer Favorites

09/06/2016	143,350	Inspection Station	Passed emissions inspection
09/14/2016		C S Cantlin Automotive Conshohocken, PA 610-834-1300 ★ 4.7 / 5.0 14 Verified Reviews ♥ 3 Customer Favorites	🔧 Vehicle serviced - Brakes serviced - Air injection pump replaced/repaired - Oxygen sensor replaced
05/05/2017	145,779	Euro Motorcars Devon, Inc. Devon, PA 610-687-1500 ★ 4.7 / 5.0 573 Verified Reviews ♥ 6,955 Customer Favorites	🔧 Vehicle serviced - Maintenance inspection completed
10/02/2017		C S Cantlin Automotive Conshohocken, PA 610-834-1300 ★ 4.7 / 5.0 14 Verified Reviews ♥ 3 Customer Favorites	🔧 Vehicle serviced - Recommended maintenance performed - Rear brake pads replaced - Rear brake rotor(s) replaced - Safety inspection performed - Emissions inspection performed
10/02/2017	146,792	Inspection Station	Exempt from emissions inspection
10/25/2017		Damage Report	📍 Damage reported: minor damage - Damage to rear

Damage Severity Scale

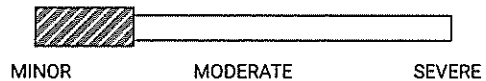

Damage Location



^ Back To Top



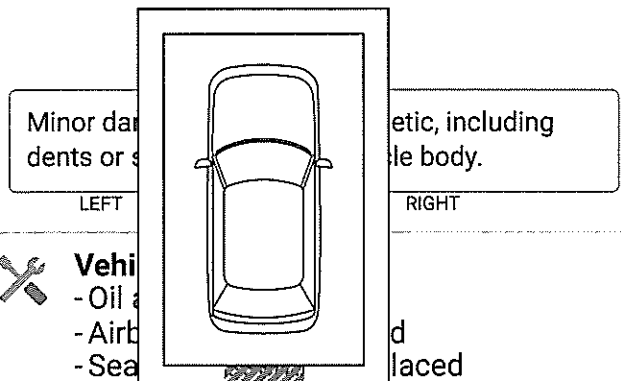

FRONT







05/28/2018	148,525	C S Cantlin Automotive Conshohocken, PA 610-834-1300 ★ 4.7 / 5.0 14 Verified Reviews ♥ 3 Customer Favorites		Vehicle serviced - Oil and filter changed - Air filter replaced - Sealant applied - Brake light bulb(s) replaced - Vehicle washed/detailed - Battery/charging system checked
08/29/2018	149,548	C S Cantlin Automotive Conshohocken, PA 610-834-1300 ★ 4.7 / 5.0 14 Verified Reviews ♥ 3 Customer Favorites		Vehicle serviced - Safety inspection performed - Tires rotated - Antifreeze/coolant flushed/changed - Emissions inspection performed - Emissions or safety inspection performed
08/29/2018		Pennsylvania Motor Vehicle Dept. Bryn Mawr, PA		Registration issued or renewed
08/30/2018		Inspection Station		Exempt from emissions inspection
09/07/2018	149,610	C S Cantlin Automotive Conshohocken, PA 610-834-1300 ★ 4.7 / 5.0 14 Verified Reviews ♥ 3 Customer Favorites		Vehicle serviced
10/09/2018	150,191	C S Cantlin Automotive Conshohocken, PA 610-834-1300 ★ 4.7 / 5.0 14 Verified Reviews ♥ 3 Customer Favorites		Vehicle serviced - Spark plug(s) replaced - Transfer case fluid flushed/changed - Antifreeze/coolant flushed/changed
03/22/2019	151,458	C S Cantlin Automotive Conshohocken, PA 610-834-1300 ★ 4.7 / 5.0 14 Verified Reviews ♥ 3 Customer Favorites		Vehicle serviced - Recommended maintenance performed - Oil and filter changed
07/25/2019		Pennsylvania Motor Vehicle Dept.		Registration issued or renewed

^ Back To Top

Bryn Mawr, PA

08/30/2019	151,787	C S Cantlin Automotive Conshohocken, PA 610-834-1300 ★ 4.7 / 5.0 14 Verified Reviews ♥ 3 Customer Favorites		Vehicle serviced - Valve body replaced - Computer(s) checked - Wheel speed sensor(s) replaced/repaired
09/19/2019	151,850	Inspection Station		Exempt from emissions inspection
09/20/2019	151,852	Mercedes-Benz of Fort Washington Fort Washington, PA 215-646-7700 ♥ 14,321 Customer Favorites		Vehicle serviced

 Owner 3 Purchased: 2019		Low mileage! This owner drove less than the industry average of 15,000 miles per year.	Personal Vehicle 60 mi/yr
---	---	---	------------------------------

Date	Mileage	Source	Comments
10/31/2019		Pennsylvania Motor Vehicle Dept. Newtown Square, PA	Vehicle purchase reported - Title issued or updated - New owner reported
03/25/2020	158,772	C S Cantlin Automotive Conshohocken, PA 610-834-1300 ★ 4.7 / 5.0 14 Verified Reviews ♥ 3 Customer Favorites	 Vehicle serviced - Front shock absorber(s) replaced
04/01/2020		Pennsylvania Motor Vehicle Dept. Newtown Square, PA	Title issued or updated - Registration issued or renewed
11/16/2020		Inspection Station	Exempt from emissions inspection
03/10/2021		Pennsylvania Motor Vehicle Dept. Newtown Square, PA	Registration issued or renewed
04/23/2022		Pennsylvania Motor Vehicle Dept. Newtown Square, PA	Registration issued or renewed
05/12/2022	158,900	Inspection Station	Exempt from emissions inspection
05/27/2022		Mercedes-Benz USA LLC	Manufacturer Safety rec  Back To Top - NHTSA #22V315

- Recall #2022050015
- Status: Remedy Available

Click here or call 1-800-367-6372 to locate an authorized Mercedes-Benz dealer near you to obtain more information about this recall

🕒 [Learn more about this recall](#)

Description: Mercedes-Benz AG ("MBAG"), the manufacturer of Mercedes-Benz vehicles, has determined that on certain Model Year ("MY") 2006-2012 ML, GL (164 platform) and R-Class (251 platform) vehicles, the function of the brake booster might be affected due to advanced corrosion in the joint area of its housing. After extended time in the field and in conjunction with significant water exposure, this corrosion might lead to a leakage of the brake booster. In this case, the brake force support might be reduced, leading to an increase in the brake pedal forces required to decelerate the vehicle and/or to potentially increased stopping distance. Additionally, in rare cases of very severe corrosion, it might be possible for a particularly strong or hard braking maneuver to cause mechanical damage in the brake booster, whereby the connection between brake pedal and brake system would fail. In such a very rare case, it would not be possible to decelerate the vehicle via the service brake. Thus, the risk of a crash or injury would be increased. The function of the foot parking brake is not affected by this issue. An authorized Mercedes-Benz dealer will remove the rubber sleeve, check the brake booster on the affected vehicles and - depending on the result of this inspection - replace as necessary.

After extended time in the field and in conjunction with significant water exposure, this corrosion might lead to a leakage of the brake booster. In this case, the brake force support might be reduced, leading to an increase in the brake pedal forces required to decelerate the vehicle and/or to potentially increased stopping distance. Additionally, in rare cases of very severe corrosion, it might be possible for a particularly strong or hard braking maneuver to cause mechanical damage in the brake booster, whereby the connection between brake pedal and brake system would fail. In such a very rare case, it would not be possible to decelerate the vehicle via the service brake. Thus, the risk of a crash or injury would be increased. The function of the foot parking brake is not affected by this issue.

Remedy: An authorized Mercedes-Benz dealer will remove the rubber sleeve, check the brake booster on the affected vehicles and - depending on the result of this inspection - replace as necessary.

02/10/2023 Pennsylvania **Registration issued or renewed**
 Motor Vehicle Dept.
 Newtown Square, PA

04/19/2023 Pennsylvania **Registration issued or renewed**
 Motor Vehicle Dept.
 Newtown Square, PA

Have Questions? Please visit our Help Center at www.carfax.com.



Glossary

Damage Indicator

^ Back To Top

Damage can be a result of many different types of events. Examples include contact with objects (other cars, trees, traffic signs, road debris, etc), vandalism, or weather-related events. Not every damage event is reported to CARFAX. As details about the damage event become available, those additional details are added to the CARFAX Vehicle History Report. CARFAX recommends that you have this vehicle inspected by a qualified mechanic.

- This CARFAX Vehicle History Report is based only on information supplied to CARFAX and available as of 7/10/24 at 1:37:02 PM (CDT). Other information about this vehicle, including problems, may not have been reported to CARFAX. Use this report as one important tool, along with a vehicle inspection and test drive, to make a better decision about your next used car.

Damage Severity

Damage events result in one of the following severity levels:

- **Minor:** Generally, minor damage is cosmetic (including dents or scratches), may only require reconditioning, and typically does not compromise a vehicle's operation and/or safety.
- **Moderate:** Moderate damage may affect multiple components of the vehicle and may impair the vehicle's operation and/or safety.
- **Severe:** Severe damage usually affects multiple components of the vehicle and is likely to compromise the vehicle's operation and/or safety.

CARFAX recommends getting a pre-purchase inspection at a certified collision repair facility.

Failed Emissions Inspection

The emissions check performed during a vehicle inspection indicated the vehicle was emitting more than allowable emissions standards and/or had missing or modified parts. Repeated failed emissions records can indicate engine problems and CARFAX recommends you have the vehicle inspected.

First Owner

When the first owner(s) obtains a title from a Department of Motor Vehicles as proof of ownership.

Manufacturer Recall

Automobile manufacturers issue recall notices to inform vehicle owners of a safety defect or failure to meet minimum federal safety or emissions standards. Manufacturer recalls are repaired at no cost to the customer.

New Owner Reported

When a vehicle is sold to a new owner, the Title must be transferred to the new owner(s) at a Department of Motor Vehicles.

Ownership History

CARFAX defines an owner as an individual or business that possesses and uses a vehicle. Not all title transactions represent changes in ownership. To provide estimated number of owners, CARFAX proprietary technology analyzes all the events in a vehicle history. Estimated ownership is available for vehicles manufactured after 1991 and titled solely in the US including Puerto Rico. Dealers sometimes opt to take ownership of a vehicle and are required to in the following states: Maine, Massachusetts, New Jersey, Ohio, Oklahoma, Pennsylvania and South Dakota. Please consider this as you review a vehicle's estimated ownership history.

Title Issued

A state issues a title to provide a vehicle owner with proof of ownership. Each title has a unique number. Each title or registration record on a CARFAX report does not necessarily indicate a change in ownership. In Canada, a registration and bill of sale are used as proof of ownership.

Follow Us:  [facebook.com/CARFAX](https://www.facebook.com/CARFAX)  [@CARFAXinc](https://twitter.com/CARFAXinc)  [About CARFAX](#)

CARFAX DEPENDS ON ITS SOURCES FOR THE ACCURACY AND RELIABILITY OF ITS INFORMATION. THEREFORE, NO RESPONSIBILITY IS ASSUMED BY CARFAX OR ITS AGENTS FOR ERRORS OR OMISSIONS IN THIS REPORT. CARFAX FURTHER EXPRESSLY DISCLAIMS ALL WARRANTIES, EXPRESS OR IMPLIED, INCLUDING ANY IMPLIED WARRANTIES OF MERCHANTABILITY OR FITNESS FOR A PARTICULAR PURPOSE.

© 2024 CARFAX, Inc., part of S&P Global. All rights reserved.
7/10/24 1:37:02 PM (CDT)

[^ Back To Top](#)