



Vehicle History Report™

2008 MERCEDES-BENZ E-CLASS E 350

VIN: WDBUF56X88B276474
SEDAN 4 DR
3.5L V6 F DOHC 24V
GASOLINE
REAR WHEEL DRIVE

Accident reported: minor damage

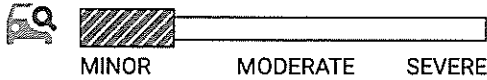

38 Service history records

At least 1 open recall

3 Previous owners

136,008 Last reported odometer reading

This CARFAX Vehicle History Report is based only on information supplied to CARFAX and available as of 7/10/24 at 1:07:21 PM (CDT). Other information about this vehicle, including problems, may not have been reported to CARFAX. Use this report as one important tool, along with a vehicle inspection and test drive, to make a better decision about your next used car.

Accident / Damage History

Not all accidents / issues are reported to CARFAX

Event 1

01/24/2014

Damage reported: minor damage

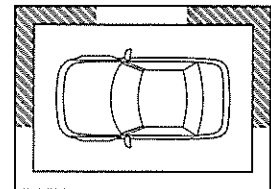
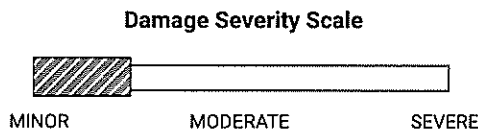

Event 2

06/18/2014

Accident reported: minor damage

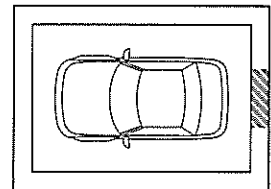
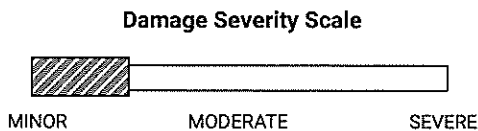

[^ Back To Top](#)

Event 3

04/06/2015

Damage reported: minor damage

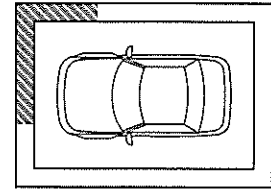
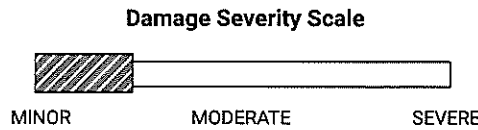

CARFAX Additional History Not all accidents / issues are reported to CARFAX	Owner 1	Owner 2	Owner 3
Total Loss No total loss reported to CARFAX.	<input checked="" type="checkbox"/> No Issues Reported	<input checked="" type="checkbox"/> No Issues Reported	<input checked="" type="checkbox"/> No Issues Reported
Structural Damage CARFAX recommends that you have this vehicle inspected by a collision repair specialist.	<input checked="" type="checkbox"/> No Issues Reported	<input checked="" type="checkbox"/> No Issues Reported	<input checked="" type="checkbox"/> No Issues Reported
Airbag Deployment No airbag deployment reported to CARFAX.	<input checked="" type="checkbox"/> No Issues Reported	<input checked="" type="checkbox"/> No Issues Reported	<input checked="" type="checkbox"/> No Issues Reported
Odometer Check No indication of an odometer rollback.	<input checked="" type="checkbox"/> No Issues Indicated	<input checked="" type="checkbox"/> No Issues Indicated	<input checked="" type="checkbox"/> No Issues Indicated
Accident / Damage Damage reported: 01/24/2014 and 04/06/2015. Accident reported: 06/18/2014.	<input checked="" type="checkbox"/> No Issues Reported	Minor Damage	No New Issues Reported
Manufacturer Recall At least 1 manufacturer recall requires repair. Most recalls can be repaired free of charge.	<input checked="" type="checkbox"/> No Recalls Reported	<input checked="" type="checkbox"/> No Recalls Reported	Recall Reported
Basic Warranty Original warranty estimated to have expired.	Warranty Expired	Warranty Expired	Warranty Expired

CARFAX Title History CARFAX guarantees the information in this section	Owner 1	Owner 2	Owner 3
Damage Brands Salvage Junk Rebuilt Fire Flood Hail Lemon	<input checked="" type="checkbox"/> Guaranteed No Problem	<input checked="" type="checkbox"/> Guaranteed No Problem	<input checked="" type="checkbox"/> Guaranteed No Problem
Odometer Brands Not Actual Mileage Exceeds Mechanical Limits	<input checked="" type="checkbox"/> Guaranteed No Problem	<input checked="" type="checkbox"/> Guaranteed No Problem	<input checked="" type="checkbox"/> Guaranteed No Problem

[^ Back To Top](#)



GUARANTEED - None of these title problems were reported by a U.S. state Department of Motor Vehicles (DMV). If you find that any of these title problems were reported by a DMV and not included in this report, you may qualify. [View Terms](#) | [View Certificate](#)

CARFAX Ownership History

The number of owners is estimated

	Owner 1	Owner 2	Owner 3
Year purchased	2008	2013	2020
Type of owner	Personal	Personal	Personal
Estimated length of ownership	4 yrs. 8 mo.	6 yrs. 11 mo.	4 yrs. 5 mo.
Owned in the following states/provinces	Pennsylvania, New Jersey	Pennsylvania	Pennsylvania
Estimated miles driven per year	14,848/yr	8,130/yr	5,615/yr
Last reported odometer reading	69,892	122,878	136,008

CARFAX Detailed History

Owner 1
Purchased: 2008

Low mileage! This owner drove less than the industry average of 15,000 miles per year.





Personal Vehicle
14,848 mi/yr

Date	Mileage	Source	Comments
12/26/2007	11	Rallye Motors, Inc. Roslyn, NY 516-801-8800 ★ 4.8 / 5.0 884 Verified Reviews ❤️ 14,036 Customer Favorites	Vehicle serviced - Pre-delivery inspection completed
12/27/2007		Keenan Motors Doylestown, PA 215-348-0800 ★ 4.3 / 5.0 15 Verified Reviews	Vehicle offered for sale
12/31/2007	14	Keenan Motors Doylestown, PA 215-348-0800 ★ 4.3 / 5.0 15 Verified Reviews	Vehicle serviced - Pre-delivery inspection completed - Emissions inspection performed - Emissions or safety inspection performed
01/08/2008		Keenan Motors	Vehicle sold

[^ Back To Top](#)





Doylestown, PA
215-348-0800

★ 4.3 / 5.0
15 Verified Reviews

01/08/2008		Pennsylvania Motor Vehicle Dept.		Vehicle purchase reported
01/10/2008		Pennsylvania Motor Vehicle Dept. Morrisville, PA		Title issued or updated - First owner reported - Titled or registered as personal vehicle
05/01/2008	3,449	Keenan Motors Doylestown, PA 215-348-0800		Vehicle serviced
		★ 4.3 / 5.0 15 Verified Reviews		
07/10/2008	6,105	Keenan Motors Doylestown, PA 215-348-0800		Vehicle serviced - Tires rotated
		★ 4.3 / 5.0 15 Verified Reviews		
12/01/2008		Pennsylvania Motor Vehicle Dept. Morrisville, PA		Registration issued or renewed
12/17/2008	11,979	Keenan Motors Doylestown, PA 215-348-0800		Vehicle serviced - Recommended maintenance performed - Tire(s) balanced - Tires rotated - Emissions inspection performed - Emissions or safety inspection performed
		★ 4.3 / 5.0 15 Verified Reviews		
12/18/2008		Inspection Station		Passed emissions inspection
09/03/2009	22,492	Keenan Motors Doylestown, PA 215-348-0800		Vehicle serviced - Recommended maintenance performed - Tire(s) balanced - Tires rotated - Tire condition and pressure checked - Tire repaired
		★ 4.3 / 5.0 15 Verified Reviews		
12/08/2009		Pennsylvania Motor Vehicle Dept. Morrisville, PA		Registration issued or renewed
12/15/2009	25,713	Keenan Motors Doylestown, PA 215-348-0800		Vehicle serviced - Emissions inspection performed - Emissions or safety inspection performed

[^ Back To Top](#)



★ 4.3 / 5.0
15 Verified Reviews

12/15/2009		Inspection Station		Passed emissions inspection
06/15/2010	32,733	Keenan Motors Doylestown, PA 215-348-0800 ★ 4.3 / 5.0 15 Verified Reviews		Vehicle serviced - Recommended maintenance performed - Battery/charging system checked - Brake fluid flushed/changed - Body electrical system checked - Tire(s) balanced - Tires rotated
08/05/2010	35,401	Keenan Motors Doylestown, PA 215-348-0800 ★ 4.3 / 5.0 15 Verified Reviews		Vehicle serviced
10/27/2010		Pennsylvania Motor Vehicle Dept. Morrisville, PA		Registration issued or renewed
12/10/2010	41,040	Inspection Station		Passed emissions inspection
02/28/2011	45,364	Mercedes-Benz of Naples Naples, FL 239-227-2622 ★ 4.7 / 5.0 754 Verified Reviews ❤️ 11,624 Customer Favorites		Vehicle serviced - Recommended maintenance performed - Maintenance inspection completed - Brake fluid flushed/changed - Transmission fluid changed - Fluids checked - Brakes checked
11/28/2011		Pennsylvania Motor Vehicle Dept. Morrisville, PA		Registration issued or renewed
12/07/2011	56,285	Inspection Station		Passed emissions inspection
01/27/2012	57,859	Keenan Motors Doylestown, PA 215-348-0800 ★ 4.3 / 5.0 15 Verified Reviews		Vehicle serviced - Recommended maintenance performed - Brake fluid flushed/changed - Wiper(s) replaced - Battery/charging system checked - Serpentine belt replaced - Wipers/washers checked - Tire(s) balanced - Tires rotated
09/14/2012	69,603	Dealer Inventory		Vehicle offered for sale
12/29/2012		Pennsylvania		Vehicle purchase reported

[^ Back To Top](#)

Motor Vehicle Dept.

01/02/2013	New Jersey Motor Vehicle Dept. Blackwood, NJ	Title issued or updated - Dealer took title of this vehicle while it was in inventory - Vehicle color noted as Black
01/04/2013	69,892 Inspection Station	Passed emissions inspection

 Owner 2 Purchased: 2013		Low mileage! This owner drove less than the industry average of 15,000 miles per year.	Personal Vehicle 8,130 mi/yr
---	---	---	---------------------------------

Date	Mileage	Source	Comments
01/15/2013		Pennsylvania Motor Vehicle Dept. Villanova, PA	Title issued or updated - New owner reported
09/22/2013		Pennsylvania Motor Vehicle Dept. Villanova, PA	Registration issued or renewed
01/16/2014	74,675	Inspection Station	Passed emissions inspection
01/24/2014		Damage Report	 Damage reported: minor damage - Damage to right front - Damage to right rear - Damage to front - Damage to rear

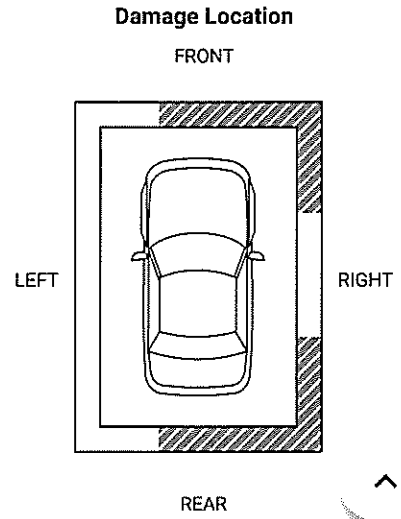
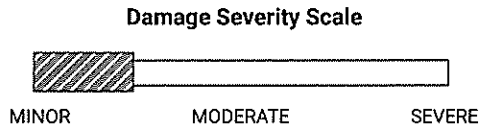

[^ Back To Top](#)



Minor damage is usually cosmetic, including dents or scratches to the vehicle body.

06/18/2014

Damage Report



Accident reported: minor damage
- Damage to rear



Damage Severity Scale

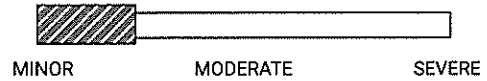

Damage Location

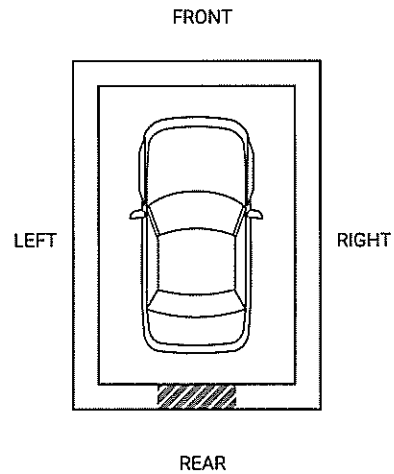

06/25/2014

Pennsylvania
Motor Vehicle Dept.
Villanova, PA

Title issued or updated

10/01/2014

Pennsylvania
Motor Vehicle Dept.
Villanova, PA

Registration issued or renewed

01/19/2015 79,412

Inspection Station

Passed emissions inspection

04/06/2015

Damage Report



Damage reported: minor damage
- Damage to right front
- Damage to front

Damage Severity Scale

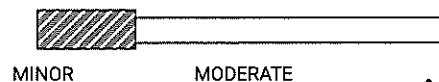

^ Back To Top





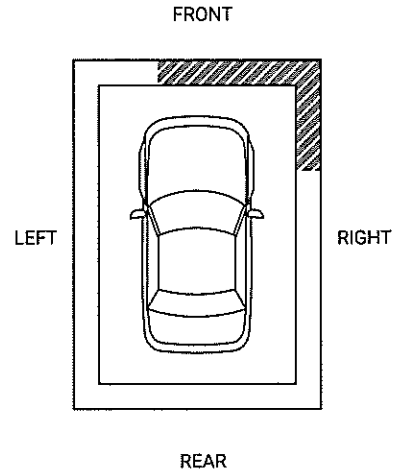



Damage Location



08/20/2015	83,772	C S Cantlin Automotive Conshohocken, PA 610-834-1300		Vehicle serviced - A/C system checked - Tire condition and pressure checked - Oil and filter changed - Fluids checked
		★ 4.7 / 5.0 14 Verified Reviews ♥ 3 Customer Favorites		
11/12/2015	85,884	C S Cantlin Automotive Conshohocken, PA 610-834-1300		Vehicle serviced - Tire(s) balanced - Tire(s) mounted
		★ 4.7 / 5.0 14 Verified Reviews ♥ 3 Customer Favorites		
01/07/2016	86,726	Inspection Station		Failed emissions inspection - Passed emissions inspection
02/19/2016	87,269	C S Cantlin Automotive Conshohocken, PA 610-834-1300		Vehicle serviced - Blower motor replaced/repared
		★ 4.7 / 5.0 14 Verified Reviews ♥ 3 Customer Favorites		
04/06/2016	87,886	C S Cantlin Automotive Conshohocken, PA 610-834-1300		Vehicle serviced
		★ 4.7 / 5.0 14 Verified Reviews ♥ 3 Customer Favorites		
04/15/2016		Pennsylvania Motor Vehicle Dept.		Title issued or updated ^ Back To Top

Drexel Hill, PA











- Registration updated when owner moved the vehicle to a new location

06/22/2016	90,134	C S Cantlin Automotive Conshohocken, PA 610-834-1300 ★ 4.7 / 5.0 14 Verified Reviews ♥ 3 Customer Favorites		Vehicle serviced
08/11/2016	91,399	C S Cantlin Automotive Conshohocken, PA 610-834-1300 ★ 4.7 / 5.0 14 Verified Reviews ♥ 3 Customer Favorites		Vehicle serviced - Oil and filter changed - Fluids checked
10/14/2016		C S Cantlin Automotive Conshohocken, PA 610-834-1300 ★ 4.7 / 5.0 14 Verified Reviews ♥ 3 Customer Favorites		Vehicle serviced - Tire repaired
11/16/2016	93,970	C S Cantlin Automotive Conshohocken, PA 610-834-1300 ★ 4.7 / 5.0 14 Verified Reviews ♥ 3 Customer Favorites		Vehicle serviced - Four tires balanced - Four tires mounted
01/11/2017	95,469	Inspection Station		Passed emissions inspection
01/12/2017	95,473	C S Cantlin Automotive Conshohocken, PA 610-834-1300 ★ 4.7 / 5.0 14 Verified Reviews ♥ 3 Customer Favorites		Vehicle serviced - Safety inspection performed - Emissions inspection performed - Emissions or safety inspection performed
03/16/2017	96,810	C S Cantlin Automotive Conshohocken, PA 610-834-1300 ★ 4.7 / 5.0 14 Verified Reviews ♥ 3 Customer Favorites		Vehicle serviced
04/03/2017	96,820	C S Cantlin Automotive Conshohocken, PA 610-834-1300 ★ 4.7 / 5.0		Vehicle serviced

[^ Back To Top](#)













14 Verified Reviews

 3 Customer Favorites



04/27/2017	97,839	C S Cantlin Automotive Conshohocken, PA 610-834-1300 ★ 4.7 / 5.0 14 Verified Reviews  3 Customer Favorites	 Vehicle serviced - Four tires balanced - Four tires mounted
05/16/2017		C S Cantlin Automotive Conshohocken, PA 610-834-1300 ★ 4.7 / 5.0 14 Verified Reviews  3 Customer Favorites	 Vehicle serviced
11/17/2017	103,101	Inspection Station	Passed emissions inspection
11/20/2017	103,108	C S Cantlin Automotive Conshohocken, PA 610-834-1300 ★ 4.7 / 5.0 14 Verified Reviews  3 Customer Favorites	 Vehicle serviced - Recommended maintenance performed - Four tires balanced - Four tires mounted - Four wheel alignment performed - Alignment performed - Safety inspection performed - Tire(s) replaced - Suspension serviced - Emissions inspection performed - Emissions or safety inspection performed
01/05/2018	104,003	C S Cantlin Automotive Conshohocken, PA 610-834-1300 ★ 4.7 / 5.0 14 Verified Reviews  3 Customer Favorites	 Vehicle serviced - Maintenance inspection completed - Glass checked - Vehicle washed/detailed
01/19/2018	104,201	C S Cantlin Automotive Conshohocken, PA 610-834-1300 ★ 4.7 / 5.0 14 Verified Reviews  3 Customer Favorites	 Vehicle serviced - Thermostat replaced
03/16/2018		C S Cantlin Automotive Conshohocken, PA 610-834-1300 ★ 4.7 / 5.0 14 Verified Reviews	 Vehicle serviced - Window(s) checked



 [Back To Top](#)

 3 Customer Favorites

04/18/2018		C S Cantlin Automotive Conshohocken, PA 610-834-1300 ★ 4.7 / 5.0 14 Verified Reviews  3 Customer Favorites	 Vehicle serviced - Lights checked
05/03/2018	106,538	C S Cantlin Automotive Conshohocken, PA 610-834-1300 ★ 4.7 / 5.0 14 Verified Reviews  3 Customer Favorites	 Vehicle serviced - Tire condition and pressure checked
10/24/2018		Pennsylvania Motor Vehicle Dept. Drexel Hill, PA	Registration issued or renewed
10/31/2018	110,166	C S Cantlin Automotive Conshohocken, PA 610-834-1300 ★ 4.7 / 5.0 14 Verified Reviews  3 Customer Favorites	 Vehicle serviced - Recommended maintenance performed - Brake fluid flushed/changed - Brakes checked - Front brake pads replaced - Tire(s) balanced - Tire(s) mounted - Tire(s) changed
11/21/2018		C S Cantlin Automotive Conshohocken, PA 610-834-1300 ★ 4.7 / 5.0 14 Verified Reviews  3 Customer Favorites	 Vehicle serviced - Front brake pads replaced
12/07/2018	112,018	C S Cantlin Automotive Conshohocken, PA 610-834-1300 ★ 4.7 / 5.0 14 Verified Reviews  3 Customer Favorites	 Vehicle serviced - Front brake pads replaced
01/29/2019	113,427	C S Cantlin Automotive Conshohocken, PA 610-834-1300 ★ 4.7 / 5.0 14 Verified Reviews  3 Customer Favorites	 Vehicle serviced - Safety inspection performed

 [Back To Top](#)

01/29/2019	113,467	Inspection Station	Exempt from emissions inspection
04/17/2019	115,668	C S Cantlin Automotive Conshohocken, PA 610-834-1300 ★ 4.7 / 5.0 14 Verified Reviews ♥ 3 Customer Favorites	 Vehicle serviced - Four wheel alignment performed - Alignment performed - Oil and filter changed - Tire(s) balanced - Tire(s) mounted - Tire(s) replaced - One tire mounted
09/06/2019	120,121	C S Cantlin Automotive Conshohocken, PA 610-834-1300 ★ 4.7 / 5.0 14 Verified Reviews ♥ 3 Customer Favorites	 Vehicle serviced - Four wheel alignment performed - Alignment performed - A/C refrigerant recharged - A/C system checked
09/06/2019		Pennsylvania Motor Vehicle Dept. Drexel Hill, PA	Registration issued or renewed
12/19/2019	122,875	Inspection Station	Passed emissions inspection
12/20/2019	122,878	C S Cantlin Automotive Conshohocken, PA 610-834-1300 ★ 4.7 / 5.0 14 Verified Reviews ♥ 3 Customer Favorites	 Vehicle serviced - Safety inspection performed - Four tires mounted - Emissions inspection performed

 Owner 3 Purchased: 2020		Low mileage! This owner drove less than the industry average of 15,000 miles per year.	Personal Vehicle 5,615 mi/yr
---	---	---	---------------------------------

Date	Mileage	Source	Comments
01/11/2020	122,900	Pennsylvania Motor Vehicle Dept.	Vehicle purchase reported
01/15/2020		Pennsylvania Motor Vehicle Dept. Conshohocken, PA	Title issued or updated - New owner reported
06/25/2020		Mercedes-Benz USA LLC	Manufacturer Safety recall issued - NHTSA #19V918 - Recall #2020040011 - Status: Remedy Available Click here or call 1-800-367-6377 to locate an authorized Me ^ Back To Top

dealer near you to obtain more information about this recall

[Learn more about this recall](#)

Description: Mercedes-Benz AG ("MBAG"), the manufacturer of Mercedes-Benz vehicles, has determined that on certain Model Year ("MY") 01-11 C-Class (203 platform), CLK-Class (209 platform), E-Class (211 platform) and CLS-Class (219 platform) vehicles, the bonding between the glass panel and the sliding roof frame might not meet specifications. In this case, the adhesion of the bonding could deteriorate gradually over time. If the bonding adhesion were to deteriorate, the durability requirements might not be met which could lead to a separation of the glass panel from the vehicle. A displaced panel could increase the risk of a potential crash or injury for other road users.

In this case, the adhesion of the bonding could deteriorate gradually over time. If the bonding adhesion were to deteriorate, the durability requirements might not be met which could lead to a separation of the glass panel from the vehicle. A displaced panel could increase the risk of a potential crash or injury for other road users.

Remedy: MBUSA will conduct a voluntary recall. An authorized Mercedes-Benz dealer will check the glass panel bonding on the affected vehicles and replace the sliding roof, as necessary.

11/13/2020	130,106	C S Cantlin Automotive Conshohocken, PA 610-834-1300		Vehicle serviced - Oil and filter changed
		★ 4.7 / 5.0 14 Verified Reviews ♥ 3 Customer Favorites		

12/16/2020		Inspection Station	Passed emissions inspection
02/09/2021		Pennsylvania Motor Vehicle Dept. Conshohocken, PA	Registration issued or renewed
11/03/2021		Pennsylvania Motor Vehicle Dept. Conshohocken, PA	Registration issued or renewed
12/09/2021		Inspection Station	Exempt from emissions inspection
05/12/2022	136,008	Inspection Station	Exempt from emissions inspection
12/27/2022		Pennsylvania Motor Vehicle Dept. Conshohocken, PA	Registration issued or renewed

Have Questions? Please visit our Help Center at www.carfax.com.



Glossary

Accident Indicator

[^ Back To Top](#)

CARFAX receives information about accidents in all 50 states, the District of Columbia and Canada.

Not every accident is reported to CARFAX. As details about the accident become available, those additional details are added to the CARFAX Vehicle History Report. CARFAX recommends that you have this vehicle inspected by a qualified mechanic.

- According to the National Safety Council, Injury Facts, 2021 edition, 5% of the 276 million registered vehicles in the U.S. were involved in an accident in 2019. Over 77% of these were considered minor or moderate.
- This CARFAX Vehicle History Report is based only on information supplied to CARFAX and available as of 7/10/24 at 1:07:21 PM (CDT). Other information about this vehicle, including problems, may not have been reported to CARFAX. Use this report as one important tool, along with a vehicle inspection and test drive, to make a better decision about your next used car.

Damage Indicator

Damage can be a result of many different types of events. Examples include contact with objects (other cars, trees, traffic signs, road debris, etc), vandalism, or weather-related events. Not every damage event is reported to CARFAX. As details about the damage event become available, those additional details are added to the CARFAX Vehicle History Report. CARFAX recommends that you have this vehicle inspected by a qualified mechanic.

- This CARFAX Vehicle History Report is based only on information supplied to CARFAX and available as of 7/10/24 at 1:07:21 PM (CDT). Other information about this vehicle, including problems, may not have been reported to CARFAX. Use this report as one important tool, along with a vehicle inspection and test drive, to make a better decision about your next used car.

Damage Severity

Damage events result in one of the following severity levels:

- Minor: Generally, minor damage is cosmetic (including dents or scratches), may only require reconditioning, and typically does not compromise a vehicle's operation and/or safety.
- Moderate: Moderate damage may affect multiple components of the vehicle and may impair the vehicle's operation and/or safety.
- Severe: Severe damage usually affects multiple components of the vehicle and is likely to compromise the vehicle's operation and/or safety.

CARFAX recommends getting a pre-purchase inspection at a certified collision repair facility.

Failed Emissions Inspection

The emissions check performed during a vehicle inspection indicated the vehicle was emitting more than allowable emissions standards and/or had missing or modified parts. Repeated failed emissions records can indicate engine problems and CARFAX recommends you have the vehicle inspected.

First Owner

When the first owner(s) obtains a title from a Department of Motor Vehicles as proof of ownership.

Manufacturer Recall

Automobile manufacturers issue recall notices to inform vehicle owners of a safety defect or failure to meet minimum federal safety or emissions standards. Manufacturer recalls are repaired at no cost to the customer.

New Owner Reported

When a vehicle is sold to a new owner, the Title must be transferred to the new owner(s) at a Department of Motor Vehicles.

Ownership History

CARFAX defines an owner as an individual or business that possesses and uses a vehicle. Not all title transactions represent changes in ownership. To provide estimated number of owners, CARFAX proprietary technology analyzes all the events in a vehicle history. Estimated ownership is available for vehicles manufactured after 1991 and titled solely in the US including Puerto Rico. Dealers sometimes opt to take ownership of a vehicle and are required to in the following states: Maine, Massachusetts, New Jersey, Ohio, Oklahoma, Pennsylvania and South Dakota. Please consider this as you review a vehicle's estimated ownership history.

Title Issued

A state issues a title to provide a vehicle owner with proof of ownership. Each title has a unique number. Each title or registration record on a CARFAX report does not necessarily indicate a change in ownership. In C

[^ Back To Top](#)