



# Vehicle History Report™

## 2010 MERCEDES-BENZ GLK 350 4MATIC

VIN: WDCGG8HB3AF443315  
4 DOOR WAGON/SPORT  
UTILITY  
3.5L V6 F DOHC 24V  
GASOLINE  
ALL WHEEL DRIVE

Accident reported

32 Service history records

5 Previous owners

Types of owners: Corporate fleet, Personal

Last owned in Pennsylvania

100,303 Last reported odometer reading

This CARFAX Vehicle History Report is based only on information supplied to CARFAX and available as of 7/10/24 at 12:51:19 PM (CDT). Other information about this vehicle, including problems, may not have been reported to CARFAX. Use this report as one important tool, along with a vehicle inspection and test drive, to make a better decision about your next used car.



## Accident / Damage History

Not all accidents / issues are reported to CARFAX

### Event 1

08/31/2015

#### Accident reported

- Vehicle involved in a side impact collision with another motor vehicle
- Airbags did not deploy

### Event 2

03/11/2019

#### Damage reported: minor damage

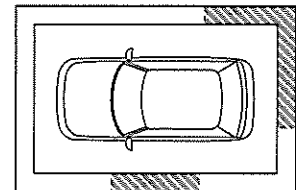
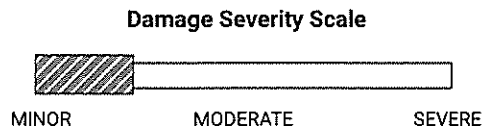

[^ Back To Top](#)

<b>CARFAX</b> Additional History Not all accidents / issues are reported to CARFAX	Owners 1-3	Owner 4	Owner 5
<b>Total Loss</b> No total loss reported to CARFAX.	<input checked="" type="checkbox"/> No Issues Reported	<input checked="" type="checkbox"/> No Issues Reported	<input checked="" type="checkbox"/> No Issues Reported
<b>Structural Damage</b> CARFAX recommends that you have this vehicle inspected by a collision repair specialist.	<input checked="" type="checkbox"/> No Issues Reported	<input checked="" type="checkbox"/> No Issues Reported	<input checked="" type="checkbox"/> No Issues Reported
<b>Airbag Deployment</b> No airbag deployment reported to CARFAX.	<input checked="" type="checkbox"/> No Issues Reported	<input checked="" type="checkbox"/> No Issues Reported	<input checked="" type="checkbox"/> No Issues Reported
<b>Odometer Check</b> No indication of an odometer rollback.	<input checked="" type="checkbox"/> No Issues Indicated	<input checked="" type="checkbox"/> No Issues Indicated	<input checked="" type="checkbox"/> No Issues Indicated
<b>Accident / Damage</b> Accident reported: 08/31/2015. Damage reported: 03/11/2019.	Accident Reported	Damage Reported	No New Issues Reported
<b>Manufacturer Recall</b> Check with an authorized Mercedes-Benz dealer for any open recalls.	<input checked="" type="checkbox"/> No Recalls Reported	<input checked="" type="checkbox"/> No Recalls Reported	<input checked="" type="checkbox"/> No Recalls Reported
<b>Basic Warranty</b> Original warranty estimated to have expired.	Warranty Expired	Warranty Expired	Warranty Expired

<b>CARFAX</b> Title History CARFAX guarantees the information in this section	Owners 1-3	Owner 4	Owner 5
<b>Damage Brands</b> Salvage   Junk   Rebuilt   Fire   Flood   Hail   Lemon	<input checked="" type="checkbox"/> Guaranteed No Problem	<input checked="" type="checkbox"/> Guaranteed No Problem	<input checked="" type="checkbox"/> Guaranteed No Problem
<b>Odometer Brands</b> Not Actual Mileage   Exceeds Mechanical Limits	<input checked="" type="checkbox"/> Guaranteed No Problem	<input checked="" type="checkbox"/> Guaranteed No Problem	<input checked="" type="checkbox"/> Guaranteed No Problem



**GUARANTEED** - None of these title problems were reported by a U.S. state Department of Motor Vehicles (DMV). If you find that any of these title problems were reported by a DMV and not included in this report, you may qualify.  
View Terms | View Certificate

<b>CARFAX</b> Ownership History The number of owners is estimated	Owners 1-3	Owner 4	Owner 5
Year purchased	2010	2017	2022
Type of owner	See Details	Personal	Personal
Estimated length of ownership	6 yrs. 9 mo.	5 yrs. 1 mo.	<a href="#">^ Back To Top</a>

Owned in the following states/provinces	See Details	Pennsylvania	Pennsylvania
Estimated miles driven per year	See Details	8,372/yr	--
Last reported odometer reading	56,097	99,990	100,303

**CARFAX** Detailed History



**Owner 1**  
Purchased: 2010

Corporate Fleet Vehicle

Date	Mileage	Source	Comments
01/07/2010	7	Mercedes-Benz of Naperville Naperville, IL 630-537-0312 ★ 4.6 / 5.0 182 Verified Reviews ♥ 156 Customer Favorites	<b>Vehicle offered for sale</b>
01/11/2010		Mercedes-Benz of Naperville Naperville, IL 630-537-0312 ★ 4.6 / 5.0 182 Verified Reviews ♥ 156 Customer Favorites	<b>Vehicle serviced</b> - Pre-delivery inspection completed - Vehicle washed/detailed
03/01/2010		Illinois Motor Vehicle Dept. Naperville, IL	<b>Titled or registered as corporate fleet vehicle</b>
04/14/2010		Illinois Motor Vehicle Dept. Naperville, IL	<b>Title issued or updated</b> - Dealer took title of this vehicle while it was in inventory - First owner reported - Loan or lien reported
08/25/2010	5,836	Mercedes-Benz of Naperville Naperville, IL 630-537-0312 ★ 4.6 / 5.0 182 Verified Reviews ♥ 156 Customer Favorites	<b>Vehicle serviced</b> - Maintenance inspection completed - Tire condition and pressure checked - Battery/charging system checked - Brakes checked - Windshield replaced
09/14/2010		Mercedes-Benz Certified Pre-Owned Dealer	<b>Offered for sale as a Mercedes-Benz Certified Pre-Owned Vehicle</b> <a href="#">^ Back To Top</a>

Mercedes-Benz **Certified**  
Pre-Owned Vehicles

09/14/2010	6,455	Mercedes-Benz of Naperville Naperville, IL 630-537-0312 ★ 4.6 / 5.0 182 Verified Reviews ♥ 156 Customer Favorites		<b>Vehicle serviced</b> - Pre-delivery inspection completed - Recommended maintenance performed - Maintenance inspection completed - Brakes checked - Battery/charging system checked - Tire condition and pressure checked - Vehicle washed/detailed
09/22/2010	6,459	Mercedes-Benz of Naperville Naperville, IL 630-537-0312 ★ 4.6 / 5.0 182 Verified Reviews ♥ 156 Customer Favorites		<b>Vehicle offered for sale</b>
09/28/2010		Mercedes-Benz of Naperville Naperville, IL 630-537-0312 ★ 4.6 / 5.0 182 Verified Reviews ♥ 156 Customer Favorites		<b>Vehicle sold</b>
11/23/2010		Illinois Motor Vehicle Dept. Wilmette, IL		<b>Registration issued or renewed</b>



**Owner 2**  
Purchased: 2010







**Low mileage!** This owner drove less than the industry average of 15,000 miles per year.

Personal Vehicle  
7,575 mi/yr

Date	Mileage	Source		Comments
11/24/2010		Illinois Motor Vehicle Dept. Wilmette, IL		<b>Title issued or updated</b> - New owner reported
04/05/2011		Illinois Motor Vehicle Dept. Wilmette, IL		<b>Registration issued or renewed</b>
05/18/2011	12,310	Loeber Motors, Inc. Lincolnwood, IL 847-675-1000		<b>Vehicle serviced</b> - 10,000 mile service per - Brakes checked

[^ Back To Top](#)

		★ <b>4.5 / 5.0</b> 144 Verified Reviews ♥ <b>157</b> Customer Favorites		- Tire condition and pressure checked - Wiper(s) replaced - Vehicle washed/detailed
12/07/2011	16,801	Loeber Motors, Inc. Lincolnwood, IL 847-675-1000 ★ <b>4.5 / 5.0</b> 144 Verified Reviews ♥ <b>157</b> Customer Favorites		<b>Vehicle serviced</b> - Tire repaired - Vehicle washed/detailed
04/03/2012		Illinois Motor Vehicle Dept. Wilmette, IL		<b>Registration issued or renewed</b>
04/27/2012	19,456	Loeber Motors, Inc. Lincolnwood, IL 847-675-1000 ★ <b>4.5 / 5.0</b> 144 Verified Reviews ♥ <b>157</b> Customer Favorites		<b>Vehicle serviced</b> - 20,000 mile service performed - Vehicle washed/detailed - Tires rotated
01/15/2013	25,230	Loeber Motors, Inc. Lincolnwood, IL 847-675-1000 ★ <b>4.5 / 5.0</b> 144 Verified Reviews ♥ <b>157</b> Customer Favorites		<b>Vehicle serviced</b> - Maintenance inspection completed - Vehicle washed/detailed - Front turn signal/parking bulb(s) replaced - One tire mounted - One tire balanced - Tire condition and pressure checked
04/11/2013		Illinois Motor Vehicle Dept. Wilmette, IL		<b>Registration issued or renewed</b>
04/23/2013	27,588	Loeber Motors, Inc. Lincolnwood, IL 847-675-1000 ★ <b>4.5 / 5.0</b> 144 Verified Reviews ♥ <b>157</b> Customer Favorites		<b>Vehicle serviced</b> - Maintenance inspection completed - 30,000 mile service performed - Vehicle washed/detailed - Tail light bulb(s) replaced - Tire condition and pressure checked
02/19/2014	33,230	Jaguar Land Rover Schaumburg Schaumburg, IL 847-252-7800 ★ <b>4.5 / 5.0</b> 28 Verified Reviews ♥ <b>1</b> Customer Favorite		<b>Vehicle offered for sale</b>
02/25/2014		Jaguar Land Rover Schaumburg		<b>Vehicle serviced</b> - Pre-delivery inspection C



[^ Back To Top](#)

Schaumburg, IL  
847-252-7800

★ 4.5 / 5.0  
28 Verified Reviews  
♥ 1 Customer Favorite



Looks like this dealer serviced the car in order to prepare it for sale. That's a good thing!

03/08/2014	Jaguar Land Rover Schaumburg Schaumburg, IL 847-252-7800 ★ 4.5 / 5.0 28 Verified Reviews ♥ 1 Customer Favorite	<b>Vehicle sold</b>
03/17/2014	33,238 Auto Auction	<b>Listed as a dealer vehicle</b> - Vehicle sold
		Millions of used vehicles are bought and sold at auction every year.
03/20/2014	Dealer Inventory	<b>Vehicle offered for sale</b>
03/29/2014	Illinois Motor Vehicle Dept.	<b>Vehicle purchase reported</b>
04/30/2014	33,657 Mercedes-Benz of Chicago Chicago, IL 312-267-0870 ★ 4.5 / 5.0 383 Verified Reviews ♥ 335 Customer Favorites	<b>Vehicle sold</b>
04/30/2014	Mercedes-Benz Of Chicago Chicago, IL 312-628-4500 ★ 4.5 / 5.0 383 Verified Reviews ♥ 335 Customer Favorites	 <b>Vehicle serviced</b> - 40,000 mile service performed - Brakes checked - Vehicle washed/detailed - Interior cleaned
06/02/2014	Illinois Motor Vehicle Dept. Chicago, IL	<b>Registration issued or renewed</b>

^ Back To Top



**Owner 3**  
Purchased: 2014



**Low mileage!** This owner drove less than the industry average of 15,000 miles per year.

Personal Vehicle  
8,202 mi/yr

Date	Mileage	Source	Comments
06/18/2014		Illinois Motor Vehicle Dept. Chicago, IL	<b>Title issued or updated</b> - New owner reported - Loan or lien reported - Vehicle color noted as White
12/27/2014	39,447	Mercedes-Benz Of Chicago Chicago, IL 312-628-4500 ★ 4.5 / 5.0 383 Verified Reviews ♥ 335 Customer Favorites	<b>Vehicle serviced</b> - Vehicle washed/detailed - Interior cleaned - Four tires mounted - Tire(s) replaced - Light bulb(s) replaced
04/11/2015	41,000	Illinois Inspection Station Chicago, IL	<b>Passed emissions inspection</b>
04/13/2015		Illinois Motor Vehicle Dept. Chicago, IL	<b>Registration issued or renewed</b>
04/16/2015	41,658	Mercedes-Benz Of Chicago Chicago, IL 312-628-4500 ★ 4.5 / 5.0 383 Verified Reviews ♥ 335 Customer Favorites	<b>Vehicle serviced</b> - 65,000 mile service performed - Electrical system checked - Light bulb(s) replaced
08/31/2015		Damage Report	<b>Accident reported</b> - Vehicle involved in a side impact collision with another motor vehicle - Airbags did not deploy
12/10/2015	47,014	Mercedes-Benz Of Chicago Chicago, IL 312-628-4500 ★ 4.5 / 5.0 383 Verified Reviews ♥ 335 Customer Favorites	<b>Vehicle serviced</b> - 60,000 mile service performed - Fuel injection system flushed/serviced - Vehicle washed/detailed - Interior cleaned - Power steering fluid flushed/changed - Tire(s) replaced - One tire replaced
01/11/2016		Mercedes-Benz Of Chicago Chicago, IL 312-628-4500	<b>Vehicle serviced</b> - Tire condition and pressure checked - Vehicle washed/detailed - Interior cleaned

[^ Back To Top](#)

★ **4.5 / 5.0**  
 383 Verified Reviews  
 ♥ **335** Customer Favorites

04/06/2016		Illinois Motor Vehicle Dept. Chicago, IL		<b>Registration issued or renewed</b> - Correction to record - Registration updated when owner moved the vehicle to a new location
05/28/2016	50,723	Mercedes-Benz of Naperville Naperville, IL 630-537-0312	✂	<b>Vehicle serviced</b> - Maintenance inspection completed - Tire(s) balanced - Tire(s) mounted
		★ <b>4.6 / 5.0</b> 182 Verified Reviews ♥ <b>156</b> Customer Favorites		
12/31/2016	55,965	Dealer Inventory		<b>Vehicle offered for sale</b>
02/28/2017	55,984	Inspection Station		<b>Passed emissions inspection</b>
03/03/2017		Pennsylvania Motor Vehicle Dept.		<b>Vehicle purchase reported</b>
03/06/2017		Inspection Station		<b>Exempt from emissions inspection</b>
03/07/2017	56,097	C S Cantlin Automotive Conshohocken, PA 610-834-1300	✂	<b>Vehicle serviced</b> - Exterior light bulb(s) replaced
		★ <b>4.7 / 5.0</b> 14 Verified Reviews ♥ <b>3</b> Customer Favorites		



**Owner 4**  
 Purchased: 2017









**Low mileage!** This owner drove less than the industry average of 15,000 miles per year.

Personal Vehicle  
 8,372 mi/yr

Date	Mileage	Source		Comments
03/16/2017		Pennsylvania Motor Vehicle Dept. Lafayette Hill, PA		<b>Title issued or updated</b> - New owner reported
11/20/2017	63,978	C S Cantlin Automotive Conshohocken, PA 610-834-1300	✂	<b>Vehicle serviced</b> - Recommended maintenance performed - Battery replaced - Tire condition and pressure checked - Fluids checked
		★ <b>4.7 / 5.0</b> 14 Verified Reviews ♥ <b>3</b> Customer Favorites		

^ Back To Top



01/10/2018		C S Cantlin Automotive Conshohocken, PA 610-834-1300 ★ 4.7 / 5.0 14 Verified Reviews ♥ 3 Customer Favorites		<b>Vehicle serviced</b> - Maintenance inspection completed - Fluids checked - Tire condition and pressure checked
03/12/2018		C S Cantlin Automotive Conshohocken, PA 610-834-1300 ★ 4.7 / 5.0 14 Verified Reviews ♥ 3 Customer Favorites		<b>Vehicle serviced</b> - Safety inspection performed - Fluids checked - Tire condition and pressure checked - Emissions inspection performed
03/12/2018	66,558	Inspection Station		<b>Passed emissions inspection</b>
10/22/2018	72,449	C S Cantlin Automotive Conshohocken, PA 610-834-1300 ★ 4.7 / 5.0 14 Verified Reviews ♥ 3 Customer Favorites		<b>Vehicle serviced</b> - Recommended maintenance performed - Four wheel alignment performed - Alignment performed - Four tires balanced - Four tires mounted - Brakes checked - Front brake pads replaced
12/21/2018	73,425	C S Cantlin Automotive Conshohocken, PA 610-834-1300 ★ 4.7 / 5.0 14 Verified Reviews ♥ 3 Customer Favorites		<b>Vehicle serviced</b> - Tire valve stem(s)/core(s) replaced
03/08/2019	74,662	C S Cantlin Automotive Conshohocken, PA 610-834-1300 ★ 4.7 / 5.0 14 Verified Reviews ♥ 3 Customer Favorites		<b>Vehicle serviced</b> - Safety inspection performed - Emissions inspection performed
03/11/2019		Inspection Station		<b>Passed emissions inspection</b>
03/11/2019		Damage Report		<b>Damage reported: minor damage</b> - Damage to rear - Damage to left side - Damage to right rear

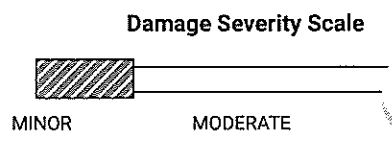



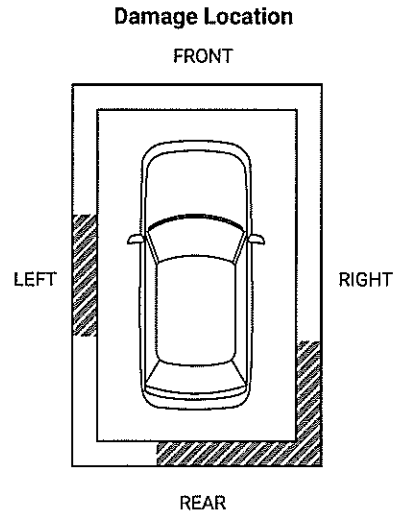







[^ Back To Top](#)



04/12/2019		Pennsylvania Motor Vehicle Dept. Lafayette Hill, PA		<b>Registration issued or renewed</b>
06/28/2019	77,277	C S Cantlin Automotive Conshohocken, PA 610-834-1300 ★ 4.7 / 5.0 14 Verified Reviews ♥ 3 Customer Favorites		<b>Vehicle serviced</b> - Oil and filter changed - Four wheel alignment performed - Alignment performed - One tire mounted - One tire balanced - Tire repaired - Tire pressure monitoring system serviced - One tire replaced
09/20/2019	79,891	C S Cantlin Automotive Conshohocken, PA 610-834-1300 ★ 4.7 / 5.0 14 Verified Reviews ♥ 3 Customer Favorites		<b>Vehicle serviced</b> - Recommended maintenance performed - One tire balanced
10/16/2019	79,894	C S Cantlin Automotive Conshohocken, PA 610-834-1300 ★ 4.7 / 5.0 14 Verified Reviews ♥ 3 Customer Favorites		<b>Vehicle serviced</b>
03/17/2020	83,220	C S Cantlin Automotive Conshohocken, PA 610-834-1300 ★ 4.7 / 5.0 14 Verified Reviews		<b>Vehicle serviced</b> - Safety inspection performed - Fuse(s) replaced - Emissions inspection pr

[^ Back To Top](#)

 3 Customer Favorites

03/17/2020		Inspection Station		<b>Passed emissions inspection</b>
04/14/2020	83,452	C S Cantlin Automotive Conshohocken, PA 610-834-1300		<b>Vehicle serviced</b>
		★ 4.7 / 5.0 14 Verified Reviews  3 Customer Favorites		
04/30/2020		Pennsylvania Motor Vehicle Dept. Lafayette Hill, PA		<b>Registration issued or renewed</b>
08/21/2020	86,401	C S Cantlin Automotive Conshohocken, PA 610-834-1300		<b>Vehicle serviced</b> - One tire mounted - One tire balanced - Tire repaired - Sunroof drain hoses serviced - Cabin air filter replaced/cleaned
		★ 4.7 / 5.0 14 Verified Reviews  3 Customer Favorites		
12/30/2020	89,562	C S Cantlin Automotive Conshohocken, PA 610-834-1300		<b>Vehicle serviced</b> - Oil and filter changed
		★ 4.7 / 5.0 14 Verified Reviews  3 Customer Favorites		
04/16/2021		Mercedes-Benz of Fort Washington Fort Washington, PA 215-646-7700		<b>Vehicle serviced</b> - Tire condition and pressure checked - Tire pressure monitoring system reset - Safety inspection performed - Emissions inspection performed
		 14,321 Customer Favorites		
04/16/2021	92,267	Inspection Station		<b>Passed emissions inspection</b>
04/20/2021		Pennsylvania Motor Vehicle Dept. Lafayette Hill, PA		<b>Registration issued or renewed</b>
05/28/2021	93,668	C S Cantlin Automotive Conshohocken, PA 610-834-1300		<b>Vehicle serviced</b> - Oil and filter changed
		★ 4.7 / 5.0 14 Verified Reviews  3 Customer Favorites		
10/14/2021	97,383	C S Cantlin Automotive Conshohocken, PA 610-834-1300		<b>Vehicle serviced</b> - Recommended maintenance performed

 [Back To Top](#)

★ **4.7 / 5.0**  
 14 Verified Reviews  
 ♥ 3 Customer Favorites

03/09/2022 99,990 Inspection Station **Passed emissions inspection**

 **Owner 5** Personal Vehicle  
 Purchased: 2022

Date	Mileage	Source	Comments
04/19/2022	100,303	Pennsylvania Motor Vehicle Dept.	<b>Vehicle purchase reported</b>
12/22/2022		Pennsylvania Motor Vehicle Dept. Conshohocken, PA	<b>Title issued or updated</b> - New owner reported

Have Questions? Please visit our Help Center at [www.carfax.com](http://www.carfax.com).



## Glossary

### Accident Indicator

CARFAX receives information about accidents in all 50 states, the District of Columbia and Canada.

Not every accident is reported to CARFAX. As details about the accident become available, those additional details are added to the CARFAX Vehicle History Report. CARFAX recommends that you have this vehicle inspected by a qualified mechanic.

- According to the National Safety Council, Injury Facts, 2021 edition, 5% of the 276 million registered vehicles in the U.S. were involved in an accident in 2019. Over 77% of these were considered minor or moderate.
- This CARFAX Vehicle History Report is based only on information supplied to CARFAX and available as of 7/10/24 at 12:51:19 PM (CDT). Other information about this vehicle, including problems, may not have been reported to CARFAX. Use this report as one important tool, along with a vehicle inspection and test drive, to make a better decision about your next used car.

### Damage Indicator

Damage can be a result of many different types of events. Examples include contact with objects (other cars, trees, traffic signs, road debris, etc), vandalism, or weather-related events. Not every damage event is reported to CARFAX. As details about the damage event become available, those additional details are added to the CARFAX Vehicle History Report. CARFAX recommends that you have this vehicle inspected by a qualified mechanic.

- This CARFAX Vehicle History Report is based only on information supplied to CARFAX and available as of 7/10/24 at 12:51:19 PM (CDT). Other information about this vehicle, including problems, may not have been reported to CARFAX. Use this report as one important tool, along with a vehicle inspection and test drive, to make a better decision about your next used car.

### Damage Severity

Damage events result in one of the following severity levels:

- **Minor:** Generally, minor damage is cosmetic (including dents or scratches), may only require reconditioning, and typically does not compromise a vehicle's operation and/or safety.
- **Moderate:** Moderate damage may affect multiple components of the vehicle and may impact vehicle's operation and/or safety.

^ [Back To Top](#)

- **Severe:** Severe damage usually affects multiple components of the vehicle and is likely to compromise the vehicle's operation and/or safety.

CARFAX recommends getting a pre-purchase inspection at a certified collision repair facility.

**First Owner**

When the first owner(s) obtains a title from a Department of Motor Vehicles as proof of ownership.

**Fleet Vehicle**

Vehicle was registered or sold to a company that manages vehicle fleets.

**New Owner Reported**

When a vehicle is sold to a new owner, the Title must be transferred to the new owner(s) at a Department of Motor Vehicles.

**Ownership History**

CARFAX defines an owner as an individual or business that possesses and uses a vehicle. Not all title transactions represent changes in ownership. To provide estimated number of owners, CARFAX proprietary technology analyzes all the events in a vehicle history. Estimated ownership is available for vehicles manufactured after 1991 and titled solely in the US including Puerto Rico. Dealers sometimes opt to take ownership of a vehicle and are required to in the following states: Maine, Massachusetts, New Jersey, Ohio, Oklahoma, Pennsylvania and South Dakota. Please consider this as you review a vehicle's estimated ownership history.

**Title Issued**

A state issues a title to provide a vehicle owner with proof of ownership. Each title has a unique number. Each title or registration record on a CARFAX report does not necessarily indicate a change in ownership. In Canada, a registration and bill of sale are used as proof of ownership.

Follow Us:



[facebook.com/CARFAX](https://www.facebook.com/CARFAX)



[@CARFAXinc](https://twitter.com/CARFAXinc)



[About CARFAX](#)

CARFAX DEPENDS ON ITS SOURCES FOR THE ACCURACY AND RELIABILITY OF ITS INFORMATION. THEREFORE, NO RESPONSIBILITY IS ASSUMED BY CARFAX OR ITS AGENTS FOR ERRORS OR OMISSIONS IN THIS REPORT. CARFAX FURTHER EXPRESSLY DISCLAIMS ALL WARRANTIES, EXPRESS OR IMPLIED, INCLUDING ANY IMPLIED WARRANTIES OF MERCHANTABILITY OR FITNESS FOR A PARTICULAR PURPOSE.

© 2024 CARFAX, Inc., part of S&P Global. All rights reserved.  
7/10/24 12:51:19 PM (CDT)

[^ Back To Top](#)