



Vehicle History Report™

2003 MERCEDES-BENZ E-CLASS E 320

VIN: WDBUF65J63A136683
 SEDAN 4 DR
 3.2L V6 F SOHC 18V
 GASOLINE
 REAR WHEEL DRIVE

Damage reported: minor damage

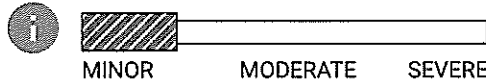

29 Service history records

3 Previous owners

Personal vehicle

164,505 Last reported odometer reading

This CARFAX Vehicle History Report is based only on information supplied to CARFAX and available as of 7/10/24 at 12:43:33 PM (CDT). Other information about this vehicle, including problems, may not have been reported to CARFAX. Use this report as one important tool, along with a vehicle inspection and test drive, to make a better decision about your next used car.

CARFAX Accident / Damage History

Not all accidents / issues are reported to CARFAX

Event 1

12/17/2019

Damage reported: minor damage

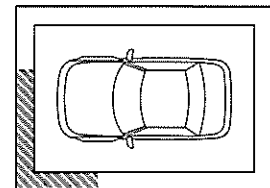
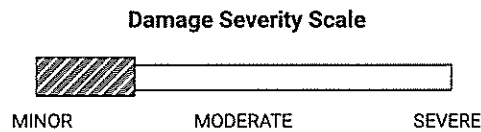

CARFAX Additional History

Not all accidents / issues are reported to CARFAX



	Owner 1	Owner 2	Owner 3
Total Loss No total loss reported to CARFAX.	<input checked="" type="checkbox"/> No Issues Reported	<input checked="" type="checkbox"/> No Issues Reported	<input checked="" type="checkbox"/> No Issues Reported
Structural Damage CARFAX recommends that you have this vehicle inspected by a collision repair specialist.	<input checked="" type="checkbox"/> No Issues Reported	<input checked="" type="checkbox"/> No Issues Reported	<input checked="" type="checkbox"/> No Issues Reported

[^ Back To Top](#)

Airbag Deployment No airbag deployment reported to CARFAX.	<input checked="" type="checkbox"/> No Issues Reported	<input checked="" type="checkbox"/> No Issues Reported	<input checked="" type="checkbox"/> No Issues Reported
Odometer Check No indication of an odometer rollback.	<input checked="" type="checkbox"/> No Issues Indicated	<input checked="" type="checkbox"/> No Issues Indicated	<input checked="" type="checkbox"/> No Issues Indicated
Accident / Damage Damage reported: 12/17/2019.	<input checked="" type="checkbox"/> No Issues Reported	<input checked="" type="checkbox"/> No Issues Reported	Minor Damage
Manufacturer Recall Check with an authorized Mercedes-Benz dealer for any open recalls.	<input checked="" type="checkbox"/> No Recalls Reported	<input checked="" type="checkbox"/> No Recalls Reported	<input checked="" type="checkbox"/> No Recalls Reported
Basic Warranty Original warranty estimated to have expired.	Warranty Expired	Warranty Expired	Warranty Expired





 Title History	Owner 1	Owner 2	Owner 3
Damage Brands Salvage Junk Rebuilt Fire Flood Hail Lemon	No Problem	No Problem	No Problem
Odometer Brands Not Actual Mileage Exceeds Mechanical Limits	No Problem	No Problem	No Problem

 Ownership History The number of owners is estimated	Owner 1	Owner 2	Owner 3
Year purchased	2002	2011	2014
Type of owner	Personal	Personal	Personal
Estimated length of ownership	7 yrs. 11 mo.	3 yrs. 2 mo.	10 yrs. 3 mo.
Owned in the following states/provinces	Massachusetts, South Carolina	South Carolina, Pennsylvania	Pennsylvania
Estimated miles driven per year	8,733/yr	9,909/yr	6,063/yr
Last reported odometer reading	74,825	102,207	164,505

 Detailed History			
 Owner 1 Purchased: 2002		Low mileage! This owner drove less than the industry average of 15,000 miles per year.	Personal Vehicle 8,733 mi/yr
Date	Mileage	Source	Comments
			^ Back To Top

09/06/2002		US Customs	Vehicle imported to - Baltimore, MD
10/25/2002		Massachusetts Motor Vehicle Dept.	Vehicle purchase reported - Titled or registered as personal vehicle
10/29/2002	25	Massachusetts Inspection Station Lynnfield, MA	Passed safety or emissions inspection
11/29/2002	27	Massachusetts Motor Vehicle Dept. Lynn, MA	Title or registration issued - First owner reported - Loan or lien reported
10/01/2003		Massachusetts Motor Vehicle Dept. Lynn, MA	Registration issued or renewed - Vehicle color noted as Black
10/20/2003	6,878	Massachusetts Inspection Station Newburyport, MA	Passed safety or emissions inspection
10/27/2004	18,521	Massachusetts Inspection Station Newburyport, MA	Passed safety or emissions inspection
10/01/2005		Massachusetts Motor Vehicle Dept. Lynn, MA	Registration issued or renewed - Vehicle color noted as Black
10/24/2005		Massachusetts Inspection Station Saugus, MA	Passed safety inspection
10/13/2006	39,750	South Carolina Motor Vehicle Dept. Saint Helena Island, SC	Registration issued or renewed
12/07/2006		Mercedes-Benz Hilton Head Okatie, SC 843-960-9650 ★ 4.5 / 5.0 10 Verified Reviews ♥ 64 Customer Favorites	 Vehicle serviced
12/18/2006		Mercedes-Benz Hilton Head Okatie, SC 843-960-9650 ★ 4.5 / 5.0 10 Verified Reviews ♥ 64 Customer Favorites	 Vehicle serviced - Lower control arm(s) replaced - Control arm(s) replaced

[^ Back To Top](#)

06/06/2007	Mercedes-Benz Hilton Head Okatie, SC 843-960-9650 ★ 4.5 / 5.0 10 Verified Reviews ♥ 64 Customer Favorites	 Vehicle serviced - Cup holder replaced
01/23/2008	South Carolina Motor Vehicle Dept. Saint Helena Island, SC	Title issued or updated
03/12/2008	Mercedes-Benz Hilton Head Okatie, SC 843-960-9650 ★ 4.5 / 5.0 10 Verified Reviews ♥ 64 Customer Favorites	 Vehicle serviced - Vehicle washed/detailed
04/02/2008	Mercedes-Benz Hilton Head Okatie, SC 843-960-9650 ★ 4.5 / 5.0 10 Verified Reviews ♥ 64 Customer Favorites	 Vehicle serviced - Brake fluid flushed/changed
06/11/2008	Mercedes-Benz Hilton Head Okatie, SC 843-960-9650 ★ 4.5 / 5.0 10 Verified Reviews ♥ 64 Customer Favorites	 Vehicle serviced - Battery replaced
06/22/2009	Mercedes-Benz Hilton Head Okatie, SC 843-960-9650 ★ 4.5 / 5.0 10 Verified Reviews ♥ 64 Customer Favorites	 Vehicle serviced - Recommended maintenance performed
05/07/2010 69,340	Mercedes-Benz Hilton Head Okatie, SC 843-960-9650 ★ 4.5 / 5.0 10 Verified Reviews	 Vehicle serviced

[^ Back To Top](#)







64 Customer Favorites

10/01/2010	69,342	Mercedes-Benz Hilton Head Okatie, SC 843-815-0300 ★ 4.7 / 5.0 338 Verified Reviews	Vehicle offered for sale
10/15/2010	74,813	Mercedes-Benz Hilton Head Okatie, SC 843-960-9650 ★ 4.5 / 5.0 10 Verified Reviews 64 Customer Favorites	Vehicle serviced - Pre-delivery inspection completed - Battery/charging system checked - Brakes checked - Oil and filter changed - Tires rotated
01/04/2011		South Carolina Motor Vehicle Dept.	Vehicle purchase reported
01/12/2011	74,825	South Carolina Motor Vehicle Dept. Hilton Head Island, SC	Registration issued or renewed

Owner 2 Purchased: 2011		Low mileage! This owner drove less than the industry average of 15,000 miles per year.	Personal Vehicle 9,909 mi/yr
-----------------------------------	--	---	---------------------------------

Date	Mileage	Source	Comments
01/17/2011		South Carolina Motor Vehicle Dept. Hilton Head Island, SC	Title issued or updated - New owner reported
07/19/2011	80,107	Pennsylvania Motor Vehicle Dept. Bryn Mawr, PA	Title issued or updated
07/22/2011	82,375	Inspection Station	Passed emissions inspection
09/21/2011	82,377	C S Cantlin Automotive Conshohocken, PA 610-834-1300 ★ 4.7 / 5.0 14 Verified Reviews 3 Customer Favorites	Vehicle serviced - License plate light bulb(s) replaced
06/21/2012		Pennsylvania Motor Vehicle Dept. Bryn Mawr, PA	Title issued or updated - Registration issued or renewed - Duplicate title issued



[^ Back To Top](#)



07/25/2012	86,272	C S Cantlin Automotive Conshohocken, PA 610-834-1300 ★ 4.7 / 5.0 14 Verified Reviews ♥ 3 Customer Favorites		Vehicle serviced - Headlight bulb(s) replaced - Four wheel alignment performed - Brake fluid flushed/changed - Vehicle washed/detailed - Rear brake pads replaced - Rear brake rotor(s) replaced
07/25/2012	89,668	Inspection Station		Passed emissions inspection
11/14/2012	93,285	Mercedes-Benz of Annapolis Annapolis, MD 410-268-2222 ★ 4.7 / 5.0 254 Verified Reviews ♥ 2,423 Customer Favorites		Vehicle serviced - Maintenance inspection completed - Battery/charging system checked
12/03/2012	93,556	C S Cantlin Automotive Conshohocken, PA 610-834-1300 ★ 4.7 / 5.0 14 Verified Reviews ♥ 3 Customer Favorites		Vehicle serviced - Vehicle washed/detailed
02/28/2013	95,767	Porsche Of Destin Destin, FL 850-650-0884 ★ 5.0 / 5.0 5 Verified Reviews ♥ 57 Customer Favorites		Vehicle serviced - Exterior trim checked
03/06/2013		C S Cantlin Automotive Conshohocken, PA 610-834-1300 ★ 4.7 / 5.0 14 Verified Reviews ♥ 3 Customer Favorites		Vehicle serviced - Vehicle washed/detailed
03/08/2013	97,106	Inspection Station		Exempt from emissions inspection
03/14/2013		C S Cantlin Automotive Conshohocken, PA 610-834-1300 ★ 4.7 / 5.0 14 Verified Reviews ♥ 3 Customer Favorites		Vehicle serviced
07/05/2013	98,692	C S Cantlin Automotive Conshohocken, PA 610-834-1300		Vehicle serviced - Vehicle washed/detailed - A/C compressor replaced



[^ Back To Top](#)

★ 4.7 / 5.0
 14 Verified Reviews
 ♥ 3 Customer Favorites







- A/C refrigerant recharged

07/31/2013	100,312	Inspection Station	Exempt from emissions inspection
08/02/2013		C S Cantlin Automotive Conshohocken, PA 610-834-1300	 Vehicle serviced
		★ 4.7 / 5.0 14 Verified Reviews ♥ 3 Customer Favorites	
10/10/2013	102,207	C S Cantlin Automotive Conshohocken, PA 610-834-1300	 Vehicle serviced - Vehicle washed/detailed
		★ 4.7 / 5.0 14 Verified Reviews ♥ 3 Customer Favorites	

 Owner 3 Purchased: 2014		Low mileage! This owner drove less than the industry average of 15,000 miles per year.	Personal Vehicle 6,063 mi/yr
---	--	---	---------------------------------

Date	Mileage	Source	Comments
04/01/2014	105,070	Pennsylvania Motor Vehicle Dept. Conshohocken, PA	Vehicle purchase reported - Title issued or updated - New owner reported
08/06/2014	105,684	Inspection Station	Passed emissions inspection
10/24/2015	115,406	Inspection Station	Passed emissions inspection
10/28/2016	125,945	Inspection Station	Passed emissions inspection
11/15/2016		C S Cantlin Automotive Conshohocken, PA 610-834-1300	 Vehicle serviced
		★ 4.7 / 5.0 14 Verified Reviews ♥ 3 Customer Favorites	
02/15/2017	128,602	C S Cantlin Automotive Conshohocken, PA 610-834-1300	 Vehicle serviced - Oil and filter changed
		★ 4.7 / 5.0 14 Verified Reviews ♥ 3 Customer Favorites	

[^ Back To Top](#)

04/26/2017		C S Cantlin Automotive Conshohocken, PA 610-834-1300 ★ 4.7 / 5.0 14 Verified Reviews ♥ 3 Customer Favorites		Vehicle serviced - Two tires mounted - Two tires balanced
09/12/2017	132,708	C S Cantlin Automotive Conshohocken, PA 610-834-1300 ★ 4.7 / 5.0 14 Verified Reviews ♥ 3 Customer Favorites		Vehicle serviced
10/24/2017	133,505	Inspection Station		Passed emissions inspection
10/25/2017	133,509	C S Cantlin Automotive Conshohocken, PA 610-834-1300 ★ 4.7 / 5.0 14 Verified Reviews ♥ 3 Customer Favorites		Vehicle serviced - Oil and filter changed - Safety inspection performed - Steering/suspension checked - Wheel bearings adjusted - Upper control arm(s) replaced - Emissions inspection performed
10/22/2018		Inspection Station		Passed emissions inspection
10/26/2018		C S Cantlin Automotive Conshohocken, PA 610-834-1300 ★ 4.7 / 5.0 14 Verified Reviews ♥ 3 Customer Favorites		Vehicle serviced - Oil and filter changed - Four wheel alignment performed - Alignment performed - Safety inspection performed - Brakes checked - Emissions inspection performed
02/28/2019	142,715	C S Cantlin Automotive Conshohocken, PA 610-834-1300 ★ 4.7 / 5.0 14 Verified Reviews ♥ 3 Customer Favorites		Vehicle serviced - Engine mount(s) replaced
06/27/2019		Pennsylvania Motor Vehicle Dept. Conshohocken, PA		Registration issued or renewed
07/02/2019	143,125	C S Cantlin Automotive Conshohocken, PA 610-834-1300 ★ 4.7 / 5.0 14 Verified Reviews ♥ 3 Customer Favorites		Vehicle serviced

[^ Back To Top](#)

10/17/2019 146,776 Inspection Station

Passed emissions inspection

12/17/2019 Damage Report



Damage reported: minor damage

- Damage to front
- Damage to left front



Damage Severity Scale

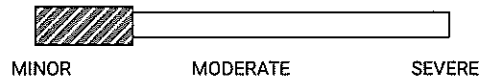

Damage Location

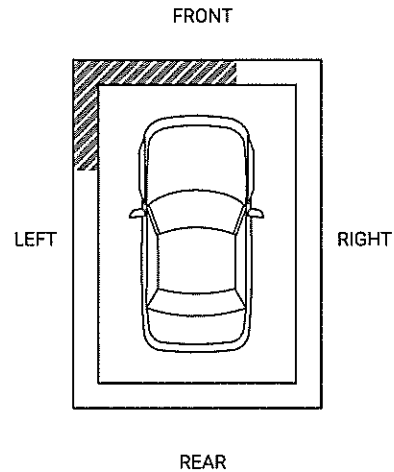

Minor damage is usually cosmetic, including dents or scratches to the vehicle body.

05/08/2020 149,001 C S Cantlin Automotive Conshohocken, PA 610-834-1300



Vehicle serviced

- Left front door lock actuator replaced
- Door lock actuator(s) replaced

★ 4.7 / 5.0
14 Verified Reviews
♥ 3 Customer Favorites

10/08/2020 Pennsylvania Motor Vehicle Dept. Conshohocken, PA

Registration issued or renewed

10/13/2020 149,737 Inspection Station

Exempt from emissions inspection

12/01/2020 C S Cantlin Automotive Conshohocken, PA 610-834-1300



Vehicle serviced

- Alignment performed

★ 4.7 / 5.0
14 Verified Reviews

^ Back To Top

 3 Customer Favorites

11/03/2021		Pennsylvania Motor Vehicle Dept. Conshohocken, PA	Registration issued or renewed
12/06/2021	154,687	Inspection Station	Exempt from emissions inspection
12/22/2022	160,042	Inspection Station	Passed emissions inspection
12/22/2022		Pennsylvania Motor Vehicle Dept. Conshohocken, PA	Registration issued or renewed
12/04/2023		Pennsylvania Motor Vehicle Dept. Conshohocken, PA	Registration issued or renewed
01/17/2024	164,505	Inspection Station	Passed emissions inspection

Have Questions? Please visit our Help Center at www.carfax.com.



Glossary

Damage Indicator

Damage can be a result of many different types of events. Examples include contact with objects (other cars, trees, traffic signs, road debris, etc), vandalism, or weather-related events. Not every damage event is reported to CARFAX. As details about the damage event become available, those additional details are added to the CARFAX Vehicle History Report. CARFAX recommends that you have this vehicle inspected by a qualified mechanic.

- This CARFAX Vehicle History Report is based only on information supplied to CARFAX and available as of 7/10/24 at 12:43:33 PM (CDT). Other information about this vehicle, including problems, may not have been reported to CARFAX. Use this report as one important tool, along with a vehicle inspection and test drive, to make a better decision about your next used car.

Damage Severity

Damage events result in one of the following severity levels:

- **Minor:** Generally, minor damage is cosmetic (including dents or scratches), may only require reconditioning, and typically does not compromise a vehicle's operation and/or safety.
- **Moderate:** Moderate damage may affect multiple components of the vehicle and may impair the vehicle's operation and/or safety.
- **Severe:** Severe damage usually affects multiple components of the vehicle and is likely to compromise the vehicle's operation and/or safety.

CARFAX recommends getting a pre-purchase inspection at a certified collision repair facility.

First Owner

When the first owner(s) obtains a title from a Department of Motor Vehicles as proof of ownership.

Inspections

Many states or counties require annual or biennial emissions and/or safety inspections. Odometer readings are collected at the time of the inspection.

New Owner Reported

When a vehicle is sold to a new owner, the Title must be transferred to the new owner(s) at a Department of Motor Vehicles.

Ownership History

[^ Back To Top](#)

CARFAX defines an owner as an individual or business that possesses and uses a vehicle. Not all title transactions represent changes in ownership. To provide estimated number of owners, CARFAX proprietary technology analyzes all the events in a vehicle history. Estimated ownership is available for vehicles manufactured after 1991 and titled solely in the US including Puerto Rico. Dealers sometimes opt to take ownership of a vehicle and are required to in the following states: Maine, Massachusetts, New Jersey, Ohio, Oklahoma, Pennsylvania and South Dakota. Please consider this as you review a vehicle's estimated ownership history.

Title Issued

A state issues a title to provide a vehicle owner with proof of ownership. Each title has a unique number. Each title or registration record on a CARFAX report does not necessarily indicate a change in ownership. In Canada, a registration and bill of sale are used as proof of ownership.

Follow Us:  facebook.com/CARFAX  [@CARFAXinc](https://twitter.com/CARFAXinc)  [About CARFAX](#)

CARFAX DEPENDS ON ITS SOURCES FOR THE ACCURACY AND RELIABILITY OF ITS INFORMATION. THEREFORE, NO RESPONSIBILITY IS ASSUMED BY CARFAX OR ITS AGENTS FOR ERRORS OR OMISSIONS IN THIS REPORT. CARFAX FURTHER EXPRESSLY DISCLAIMS ALL WARRANTIES, EXPRESS OR IMPLIED, INCLUDING ANY IMPLIED WARRANTIES OF MERCHANTABILITY OR FITNESS FOR A PARTICULAR PURPOSE.

© 2024 CARFAX, Inc., part of S&P Global. All rights reserved.
7/10/24 12:43:33 PM (CDT)

[^ Back To Top](#)