



Vehicle History Report™

US \$39.99

2017 CHEVROLET CRUZE LT

VIN: 1G1BE5SM3H7273582
 SEDAN 4 DR
 1.4L I4 F DOHC 16V
 GASOLINE
 FRONT WHEEL DRIVE



Damage reported: minor damage

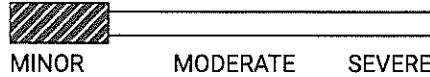

2 Previous owners



6 Service history records



Personal vehicle



20,270 Last reported odometer reading



This CARFAX Vehicle History Report is based only on information supplied to CARFAX and available as of 1/14/22 at 8:30:44 AM (CST). Other information about this vehicle, including problems, may not have been reported to CARFAX. Use this report as one important tool, along with a vehicle inspection and test drive, to make a better decision about your next used car.



Ownership History

The number of owners is estimated

Owner 1

Owner 2

Year purchased

2017

2019

Type of owner

Personal

Personal

Estimated length of ownership

2 yrs. 3 mo.

2 yrs. 1 mo.

Owned in the following states/provinces

Pennsylvania

Pennsylvania

Estimated miles driven per year

8,774/yr

—

Last reported odometer reading

20,266

20,270



Title History

CARFAX guarantees the information in this section

Owner 1

Owner 2

Salvage | Junk | Rebuilt | Fire | Flood | Hail | Lemon

Guaranteed No Problem

Guaranteed No Problem

Not Actual Mileage | Exceeds Mechanical Limits

Guaranteed No Problem

Guaranteed No Problem



GUARANTEED - None of these major title problems were reported by a state Department of Motor Vehicles (DMV). If you find that any of these title problems were reported by a DMV and not included in this report, CARFAX will buy this vehicle back. Register | View Terms | View Certificate



Additional History

Not all accidents / issues are reported to CARFAX

Owner 1

Owner 2

Total Loss
 No total loss reported to CARFAX.

No Issues Reported

No Issues Reported

Structural Damage

No Issues Reported

No Issues Reported

CARFAX recommends that you have this vehicle inspected by a collision repair specialist.		
Airbag Deployment No airbag deployment reported to CARFAX.	<input checked="" type="checkbox"/> No Issues Reported	<input checked="" type="checkbox"/> No Issues Reported
Odometer Check No indication of an odometer rollback.	<input checked="" type="checkbox"/> No Issues Indicated	<input checked="" type="checkbox"/> No Issues Indicated
Accident / Damage Damage reported: 08/30/2019.	Minor Damage	No New Issues Reported
Manufacturer Recall No open recalls reported to CARFAX. Check for open recalls on GM vehicles at recalls.gm.com .	<input checked="" type="checkbox"/> No Recalls Reported	<input checked="" type="checkbox"/> No Recalls Reported
Basic Warranty Original warranty estimated to have expired.	Warranty Expired	Warranty Expired



Detailed History

Owner 1

Purchased:
2017















Low mileage! This owner drove less than the industry average of 15,000 miles per year.

Personal Vehicle
8,774 mi/yr

Date	Mileage	Source	Comments
Original Equipment		OnStar	Vehicle equipped with OnStar Get 3 free months of premium OnStar with Automatic Crash Response, Roadside Assistance and Remote Door Unlock by pressing the blue OnStar button Learn more
07/19/2017		Reedman -Toll Auto World Langhorne, PA 215-757-4961 reedman.com ★ 4.2 / 5.0 646 Verified Reviews 619 Customer Favorites	Vehicle offered for sale
07/31/2017	6	Reedman -Toll Auto World Langhorne, PA 215-757-4961 reedman.com ★ 4.2 / 5.0 646 Verified Reviews 619 Customer Favorites	Vehicle serviced - Pre-delivery inspection completed
07/31/2017		Inspection Station	Exempt from emissions inspection
08/05/2017	11	Reedman -Toll Auto World Langhorne, PA 215-757-4961 reedman.com ★ 4.2 / 5.0 646 Verified Reviews 619 Customer Favorites	Vehicle sold
08/05/2017		Pennsylvania Motor Vehicle Dept.	Vehicle purchase reported - Titled or registered as personal vehicle
08/15/2017		Pennsylvania	Title issued or updated

Motor Vehicle Dept.
Philadelphia, PA
Title #7789224001 PO

- First owner reported

08/18/2017	15	Reedman -Toll Auto World Langhorne, PA 215-757-4961 reedman.com ★ 4.2 / 5.0 646 Verified Reviews   619 Customer Favorites	 Vehicle serviced
11/18/2017		Pennsylvania Motor Vehicle Dept. Philadelphia, PA Title #7789224001 PO	Registration issued or renewed
05/18/2018	5,437	Reedman -Toll Auto World Langhorne, PA 215-757-4961 reedman.com ★ 4.2 / 5.0 646 Verified Reviews   619 Customer Favorites	 Vehicle serviced - Maintenance inspection completed - Oil and filter changed - Tires rotated - Emissions or safety inspection performed
12/04/2018	10,858	Reedman -Toll Auto World Langhorne, PA 215-757-4961 reedman.com ★ 4.2 / 5.0 646 Verified Reviews   619 Customer Favorites	 Vehicle serviced - Maintenance inspection completed - Tires rotated
05/23/2019	15,836	Reedman -Toll Auto World Langhorne, PA 215-757-4961 reedman.com ★ 4.2 / 5.0 646 Verified Reviews   619 Customer Favorites	 Vehicle serviced - Maintenance inspection completed - Oil and filter changed - Emissions or safety inspection performed
05/23/2019		Inspection Station	Passed emissions inspection
08/29/2019		Pennsylvania Motor Vehicle Dept. Philadelphia, PA Title #7789224001 PO	Registration issued or renewed
08/30/2019		Damage Report	 Damage reported: minor damage - Damage to left side

Damage Severity Scale ⓘ

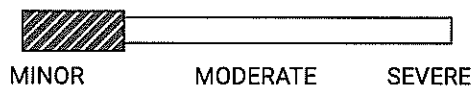

Damage Location

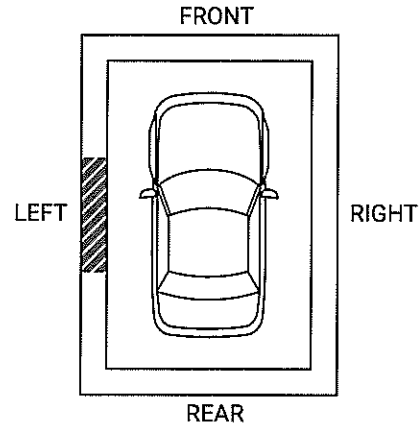

Minor damage is usually cosmetic, including dents or scratches to the vehicle body.

11/23/2019		Kia of Lansdale Lansdale, PA 267-436-3466 kiaoflansdale.com ★ 4.5 / 5.0 32 Verified Reviews	Vehicle offered for sale
11/26/2019	20,266	Inspection Station	Passed emissions inspection
11/27/2019		Kia of Lansdale Lansdale, PA 267-436-3466 kiaoflansdale.com ★ 4.5 / 5.0 32 Verified Reviews	Vehicle serviced - Pre-delivery inspection completed - Oil and filter changed - Air filter replaced - Cabin air filter replaced/cleaned
11/30/2019		Kia of Lansdale Lansdale, PA 267-436-3466 kiaoflansdale.com ★ 4.5 / 5.0 32 Verified Reviews	Vehicle sold

Owner 2			Personal Vehicle
Purchased: 2019			
Date	Mileage	Source	Comments
11/30/2019	20,270	Pennsylvania Motor Vehicle Dept.	Vehicle purchase reported
12/11/2019		Pennsylvania	Title issued or updated

Motor Vehicle Dept.
Hatfield, PA
Title #7789224002 CL

- New owner reported
- Loan or lien reported

12/19/2020

Pennsylvania
Motor Vehicle Dept.
Hatfield, PA
Title #7789224002 CL

Registration issued or renewed

Have Questions? Please visit our Help Center at www.carfax.com.



Glossary

Damage Indicator

Damage can be a result of many different types of events. Examples include contact with objects (other cars, trees, traffic signs, road debris, etc), vandalism, or weather-related events. Not every damage event is reported to CARFAX. As details about the damage event become available, those additional details are added to the CARFAX Vehicle History Report. CARFAX recommends that you have this vehicle inspected by a qualified mechanic.

- This CARFAX Vehicle History Report is based only on information supplied to CARFAX and available as of 1/14/22 at 8:30:44 AM (CST). Other information about this vehicle, including problems, may not have been reported to CARFAX. Use this report as one important tool, along with a vehicle inspection and test drive, to make a better decision about your next used car.

Damage Severity

Damage events result in one of the following severity levels:

- **Minor:** Generally, minor damage is cosmetic (including dents or scratches), may only require reconditioning, and typically does not compromise a vehicle's operation and/or safety.
- **Moderate:** Moderate damage may affect multiple components of the vehicle and may impair the vehicle's operation and/or safety.
- **Severe:** Severe damage usually affects multiple components of the vehicle and is likely to compromise the vehicle's operation and/or safety.

CARFAX recommends getting a pre-purchase inspection at a certified collision repair facility.

First Owner

When the first owner(s) obtains a title from a Department of Motor Vehicles as proof of ownership.

New Owner Reported

When a vehicle is sold to a new owner, the Title must be transferred to the new owner(s) at a Department of Motor Vehicles.

Ownership History

CARFAX defines an owner as an individual or business that possesses and uses a vehicle. Not all title transactions represent changes in ownership. To provide estimated number of owners, CARFAX proprietary technology analyzes all the events in a vehicle history. Estimated ownership is available for vehicles manufactured after 1991 and titled solely in the US including Puerto Rico. Dealers sometimes opt to take ownership of a vehicle and are required to in the following states: Maine, Massachusetts, New Jersey, Ohio, Oklahoma, Pennsylvania and South Dakota. Please consider this as you review a vehicle's estimated ownership history.

Title Issued

A state issues a title to provide a vehicle owner with proof of ownership. Each title has a unique number. Each title or registration record on a CARFAX report does not necessarily indicate a change in ownership. In Canada, a registration and bill of sale are used as proof of ownership.

Follow Us:



[facebook.com/CARFAX](https://www.facebook.com/CARFAX)



@CARFAXinc



About CARFAX

CARFAX DEPENDS ON ITS SOURCES FOR THE ACCURACY AND RELIABILITY OF ITS INFORMATION. THEREFORE, NO RESPONSIBILITY IS ASSUMED BY CARFAX OR ITS AGENTS FOR ERRORS OR OMISSIONS IN THIS REPORT. CARFAX FURTHER EXPRESSLY DISCLAIMS ALL WARRANTIES, EXPRESS OR IMPLIED, INCLUDING ANY IMPLIED WARRANTIES OF MERCHANTABILITY OR FITNESS FOR A PARTICULAR PURPOSE.

© 2022 CARFAX, Inc., a unit of IHS Markit Ltd. All rights reserved.
1/14/22 8:30:44 AM (CST)



VEHICLE HIGHLIGHTS

2017 CHEVROLET CRUZE LT

VIN: 1G1BE5SM3H7273582

Body Style: SEDAN 4 DR

Engine Size: 1.4L I4 F DOHC 16V

Drivetrain: FRONT WHEEL DRIVE

Original Manufacturer's Warranty:

Basic Warranty Expired
Please confirm remaining factory warranty and extended warranty options with your dealer!

The original manufacturer's warranty includes:
36 months or 36,000 miles

Information excerpted from the CARFAX Vehicle History Report and/or Safety & Reliability Ratings; see full reports for additional information, glossary of terms, source attributions, disclaimers & limitations. Go to carfax.com for complete Buyback Guarantee terms and conditions.

OWNERSHIP HISTORY:

Number of Owners:	2
Last owned in the following state/province:	Pennsylvania

STATE DMV-REPORTED TITLE PROBLEMS:

None of these major title problems were reported by a state Department of Motor Vehicles:



Salvage, Junk, Rebuilt, Fire, Flood, Hail, Lemon	Guaranteed No Problem
Not Actual Mileage, Exceeds Mechanical Limits	Guaranteed No Problem

ACCIDENTS AND OTHER ISSUES:

No issues reported to CARFAX on the following:

Total Loss	<input checked="" type="checkbox"/> No Issues Reported
Structural Damage	<input checked="" type="checkbox"/> No Issues Reported
Airbag Deployment	<input checked="" type="checkbox"/> No Issues Reported
Odometer Rollback	<input checked="" type="checkbox"/> No Issues Reported

Minor damage reported on this vehicle. Please see the full CARFAX Vehicle History Report for more details.

SHOW ME THE CARFAX